

Two Way Radios
for Professional and
Personal Use

**KEEP YOUR HANDS ON
THE STEERING WHEEL
WHILE DRIVING !**

M-899 VOX

CONVENIENT REMOTE PTT CONTROL AND EXTERNAL
EARSET-MICROPHONE INCLUDED !
REAL HANDSFREE OPERATION IN VOX MODE

SAFE DRIVE RADIO !



KT-900EE
Amateur Radio 144-430 MHz
5W Dual Band Handheld

**Best VHF/UHF
Dual Band
Transceiver
(check HAM
Radio forums
on the Web)**

CB MONITOR ROAD WATCHER CBM-450

**Free use
no license !**



Real time information while driving !

Listen to radio communication from trucks and other vehicles and keep yourself informed on what's going on the road! Real time information on traffic condition, jams, accidents, police check-points, speed controls, etc. Complete with antenna and 12V car lighter adaptor.

INDEX



New Products Showroom
page 1-2 / 61



CB Transceivers
page 3-11



Amateur Radio Transceivers
page 12-15



Professional Transceivers
page 16-19



PMR/LPD 2-Band Transceivers
page 20-21



LPD433/PMR446 Walkie-Talkies
page 22-23



43MHz Transceivers
page 24



Marine VHF Transceivers
page 25



Accessories
page 26-29



Power Supplies / Converters
page 30-31



Pagers, Alarms, Safety
page 32-34



Scanning Receivers
page 35



Shortwave Receivers
page 35-36



SIRTEL Antenne
page 37-47



SIGMA Antenne
page 48-60

CUSTOMERS INFORMATION

All INTEK products are in full compliance with the current European CE / R&TTE and RoHS regulations. A Declaration of Conformity is included in each product and the approval marks are printed on the packaging and/or on the user manual. Full details on the type approval documents may be requested and obtained from our service department. It is the user's responsibility to check local regulations in the country where radios are to be used, before operating it.



www.intek-radios.com

**A completely renewed Website !
Please visit it for
new products information
specifications and user manuals
downloads and more**

M-899 VOX

NEW !



New Multi-Standard CB radio with extra large blue color LCD. Convenient Remote PTT Control Box and external Earset-Microphone included. Real handsfree operation in VOX mode. Three operating modes for transmitting and three operating modes for receiving !

SAFE DRIVE RADIO !
CONVENIENT REMOTE PTT CONTROL AND EXTERNAL
EARSET-MICROPHONE INCLUDED !
REAL HANDSFREE OPERATION IN VOX MODE

(page 7)

M-60 PLUS

NEW !



New Multi-Standard CB radio with 3-digit blue color LCD. Convenient Remote PTT Control Box and external Microphone jacks, for safe operation while driving. Automatic Noise Limiter, EMG channels, fixed or manual Squelch, S/R/F Meter. Radio can be used in every European country.

SAFE DRIVE RADIO !
CONVENIENT REMOTE PTT CONTROL AND EXTERNAL
MICROPHONE JACKS !
COMPACT SIZE FITS EVERY VEHICLE !

(page 7)

CB MONITOR ROAD WATCHER NEW !

CBM-450

**Free use
no license !**



Real time information while driving !

Listen to radio communication from trucks and other vehicles and keep yourself informed on what's going on the road! Real time information on traffic condition, jams, accidents, police check-points, speed controls, etc. Complete with antenna and 12V car lighter adaptor.

(page 11)

HR-2800EU

NEW !

AM-FM 20W



Amateur Radio 10-Meter band (28 MHz) mobile transceiver. Range 28.000-29.700 KHz, 5 KHz frequency steps, AM/FM modes, TX RF power 20W. ESP Speech Processor and DC-DC converter (accepts 12-32Vcc input voltage).

(HR-2800EX International Version, includes all CB bands and frequency range 25.610-30.105 KHz. Not available for sale and use in the European countries).

AMATEUR RADIO 10-METER BAND (page 12)

KT-950EE

NEW !

23 mm THICK !

RF POWER 2W



Amateur Radio VHF/UHF FM 144-430 MHz Dual Band PC programmable real pocket size transceiver, only 47 x 81 x 23 mm, the size of a cigarette box! 2W RF transmitter, Dual Frequency, Dual Display, Dual Stand-by. Full set includes all accessories.

(page 15)

REAL POCKET SIZE VHF-UHF DUAL BAND !

HR-5500

NEW !

AM 1-12W / FM 2-40W
USB-LSB 0-40W

AM-FM-SSB-CW

PC PROGRAMMABLE



Amateur Radio 10-Meter band (28 MHz) ALL MODE mobile transceiver. Range 28.000-29.700 KHz, 7-digit extra bright frequency display, SWR Meter, RF Gain, RF PWR, NB, etc.

(HR-5500EX International Version, includes all CB bands and frequency range 25.610-30.105 KHz. Not available for sale and use in the European countries).

AMATEUR RADIO 10-METER BAND (page 13)

KT-930EE

NEW !

2200 mAh BATTERY

5W VHF / 4W UHF



Amateur Radio VHF/UHF FM 144-430 MHz Dual Band PC programmable, VOX, CTCSS, DCS, Wide/Narrow selection, Multi-Display function, Multi-Scan function, extra high capacity battery pack. Dual Frequency, Dual Display, Dual Stand-by. Full set includes all accessories.

(page 15)

EXTRA RUGGED VHF-UHF DUAL BAND !

COMMUNICATION RECEIVERS

NEW !

HF/SW-MW-LW-FM-AIR

AM-FM-SSB



Amateur Radio & World Shortwave Communication receivers, VHF Air Band, ALL MODE, up to 1000 memories, professional construction with metal weighted knobs and much more !

THREE MODELS AVAILABLE ! (page 35)



TWO WAY RADIOS AND ELECTRONICS SINCE 1976 !

In the world of the young and fast moving electronics community, INTEK may be certainly called an “old” company, as its founding dates back to some thirty six years ago, exactly to february 1976. Since then, the Company mission has been the design, development and production of advanced and competitive two way radios and RF communication devices for both consumer, amateur and professional use. By combining a almost unique over thirty years experience and excellent know-how in the two-way radios area with a deep market understanding as a European based and integrated company, INTEK is offering a number of original products that perfectly match all the specific wishes and requirements of western and eastern European customers, like no other Asian manufacturers can do. Currently, a team of more than 50 enthusiastic people provide their services and efforts in what we call “the project”, among them several hardware, software and design engineers hardly and carefully work daily to create products, following ours and Customers suggestions and making ideas become real products, as well as business opportunities for all our customers, in as short as six-to-eight months time since the first idea is born and the first sketch is drawn on our computers. INTEK Electronics (China) Limited, based in Hong Kong, is handling and controlling the developing and manufacturing processes in China (Shenzhen and Dongguan factories) and in some other Asian countries, as well as materials procurement, while INTEK S.R.L. based in Italy is handling the worldwide distribution and sales of the products, as well as all necessary type approval tests and certifications. Our product range includes 27 MHz CB radios, HF, VHF and UHF AMATEUR RADIO transceivers, LPD433, PMR446, VHF and UHF commercial LMR radios, VHF MARINE transceivers, scanning receivers, shortwave amateur receivers, antennas and accessories. Please visit our website www.intek-radios.com to check for our latest products categories, including electronic hobby tools and devices, outdoor electronic products and more.



INTEK S.R.L. headquarters in Segrate, Italy

SALES NETWORK

INTEK products are distributed and available in almost all the European countries and in some other non European countries, through selected exclusive distributors. Please check our website www.intek-radios.com for Distributors and Dealers information. Distributorship is steel available in selected countries. Please contact our sales office for full details.

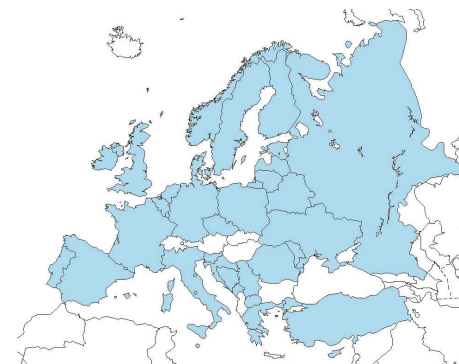

CB RADIOS

27 MHz CITIZEN BAND MOBILE AND HANDHELD
 MULTI-STANDARD TRANSCEIVERS
 27 MHz CITIZEN BAND MONITOR (ROAD WATCHER)



M-100 PLUS

ULTRA-COMPACT / 10cm WIDE !

**3-DIGIT CHANNEL/BAND
BLUE COLOR LCD DISPLAY**

ANL / EMG



CB 27 MHz PROGRAMMABLE MULTI-STANDARD MOBILE TRANSCEIVER

Multi-Standard CB mobile transceiver. 4W AM/FM. The main feature of this model is its extreme compact size, only 10 cm wide, for a very easy installation even in the current smallest cars. Radio has total 9 bands programmable, for use in all the european countries. **3-digit blue color LCD band/channel backlit display**, for a clear indication of band ID code, channel number and other enabled functions. High efficiency ANL (Automatic Noise Limiter), slow or fast channel selection, quick access to CH9/CH19 emergency channels. Silicon rubber keys with backlighting. Professional construction with multi-layer circuit design. Extra soft microphone curl cord and 3W speaker. One of most compact multi-band mobile CB radios in the World !

Art. 05000100

Main Features

- > 9 Bands Programmable (all european countries)
- > AM/FM 4W
- > 3-Digit Band/Channel Blue Color LCD Display
- > ANL (Automatic Noise Limiter)
- > EMG (Emergency Channels) quick access
- > Quick UP/DN channel selection
- > 3W Speaker
- > Soft type microphone curl cord
- > 4-pin Mic Connector

M-100EX PLUS
International Version, features 12 bands, 450 channels including 50 Alpha channels. Not available for sale or use in the EEC countries.

Band/channel 3-digit blue color LCD display for clear indication of band ID code, channel number and current enabled functions



FULL KIT PACKAGES

NO INSTALLATION REQUIRED !

**ALL-YOU-NEED READY-TO-START
FULL KIT VERSIONS**



**MULTI-STANDARD CB TRANSCEIVERS READY-TO-START
FULL KIT PACKAGES INCLUDE CB MAGNET ANTENNA AND
12VDC CAR PLUG ADAPTOR**

These "all-you-need" and "ready-to-start" FULL KIT mobile CB radio packages include all you need to operate your CB transceiver immediately after purchase. No installation is required. Each package includes the mobile CB transceiver ① complete with a 12V car cigarette lighter adaptor plug ② (connect directly to the lighter socket in your car) and a high performance CB magnet mount antenna ③ (mod. MAG-1345) complete with 4 mt. RG-58U cable and PL-259 connector (connect to the CB transceiver).

Available Models

- | | |
|----------------|---------------|
| M-100 PLUS F/K | Art. 05009001 |
| M-120 PLUS F/K | Art. 05009002 |
| M-130 PLUS F/K | Art. 05009013 |
| M-799 PLUS F/K | Art. 05009019 |

Be on the air in just 60 seconds !





M-120 PLUS

3-DIGIT CHANNEL/BAND
LED DISPLAY

ASQ / EMG



CB 27 MHz PROGRAMMABLE MULTI-STANDARD MOBILE TRANSCEIVER

Multi-Standard CB mobile transceiver. 4W AM/FM. Compact size cabinet. Radio has total 9 bands programmable, for use in all the european countries. **3-digit LED band/channel display**, for a clear indication of band ID code and channel number. Auto (fixed) or manual Squelch, slow or fast channel selection, quick access to CH9/CH19 emergency channels. Silicon rubber channel keys. Professional construction with multi-layer circuit design. Extra soft microphone curl cord and 3W speaker.

Art. 05000302

Main Features

- > 9 Bands Programmable (all european countries)
- > AM/FM 4W
- > 3-Digit Band/Channel LED Display
- > Manual or Auto (fixed) Squelch
- > EMG (Emergency Channels) quick access
- > Quick UP/DN channel selection
- > 3W Speaker
- > Soft type microphone curl cord
- > 4-pin Mic Connector

M-120EX PLUS
International Version, features 12 bands, 450 channels including 50 Alpha channels. Not available for sale or use in the EEC countries.

Band/channel 3-digit LED display for clear indication of band ID code and channel number.



M-130 PLUS

3-DIGIT CHANNEL/BAND
BLUE COLOR LCD DISPLAY

RF GAIN CONTROL

ASQ / ANL / EMG



CB 27 MHz PROGRAMMABLE MULTI-STANDARD MOBILE TRANSCEIVER

Multi-Standard CB mobile transceiver. 4W AM/FM. Compact size cabinet. Radio has total 9 bands programmable, for use in all the european countries. **3-digit blue color LCD band/channel backlit display**, for a clear indication of band ID code, channel number and other enabled functions. Auto (fixed) or manual Squelch, high efficiency ANL (Automatic Noise Limiter), slow or fast channel selection, quick access to CH9/CH19 emergency channels. **RF GAIN control**. Silicon rubber keys with backlighting. Professional construction with multi-layer circuit design. Extra soft microphone curl cord and 3W speaker.

Art. 05000305

Main Features

- > 9 Bands Programmable (all european countries)
- > AM/FM 4W
- > 3-Digit Band/Channel Blue Color LCD Display
- > Manual or Auto (fixed) Squelch
- > RF GAIN Control
- > ANL (Automatic Noise Limiter)
- > EMG (Emergency Channels) quick access
- > Quick UP/DN channel selection
- > 3W Speaker
- > Soft type microphone curl cord
- > 4-pin Mic Connector

M-130EX PLUS
International Version, features 12 bands, 450 channels including 50 Alpha channels. Not available for sale or use in the EEC countries.

Band/channel 3-digit blue color LCD display for clear indication of band ID code, channel number and current enabled functions





M-799 PLUS

EXTRA LARGE BLUE COLOR LCD !

ESP RX-TX SPEECH PROCESSOR

DYNAMIC MIC

ASQ / ANL / SCAN

DW / RB / RF ATT



CB 27 MHz PROGRAMMABLE MULTI-STANDARD MOBILE TRANSCEIVER

Compact size 4W AM/FM CB mobile radio. 9 bands programmable, for use in all the european countries. **Extra large blue color LCD backlighted display**, shows band ID code, channel number and every other enabled function. Digital S/Rf Meter. Auto (fixed) or manual Squelch, high efficiency ANL (Automatic Noise Limiter), slow or fast channel selection, quick access to CH9/CH19 emergency channels. **ESP COMPANDER (RX/TX Speech Processor)**. Additional feauters include ATT (received signal attenuator), RB (Roger Beep Tone), SCAN and DW (Dual Watch). High quality Dynamic Microphone with UP/DN/LOCK controls. Silicon rubber keys with backlighting. Professional construction with multi-layer circuit design. Extra soft microphone curl cord and 3W speaker.

Main Features

- > 9 Bands Programmable (all european countries)
- > AM/FM 4W
- > Extra large Blue Color LCD Display with S/Rf Meter
- > ESP COMPANDER (RX/TX Speech Processor)
- > Manual or Auto (fixed) Squelch / 3W Speaker
- > ATT (RF Signal Attenuator) / RB (Roger Beep)
- > ANL (Automatic Noise Limiter) / SCAN / DW
- > EMG (Emergency Channels) quick access
- > Quick UP/DN channel selection
- > Soft type microphone curl cord
- > Dynamic MIC with UP/DN/LOCK controls

Art. 05000312

M-799EX PLUS

International Version, features 14 bands, 450 channels including 50 Alpha channels. Not available for sale or use in the EEC countries.

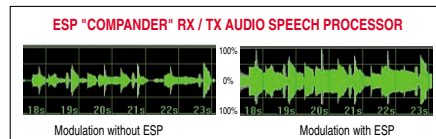

M-490 PLUS

DIGITAL FREQUENCY READOUT !

ESP RX-TX SPEECH PROCESSOR

DYNAMIC MIC

1 + 4 MEMORY CH

RF GAIN / MIC GAIN



CB 27 MHz PROGRAMMABLE MULTI-STANDARD MOBILE TRANSCEIVER

Advanced Multi-Standard CB mobile transceiver. 10 bands programmable for use in every european country. Digital **ESP COMPANDER (RX/TX Speech Processor)** increases modulation level in transmission (Compressor) and audio modulation level in reception (Expander). Wide LCD Display shows channel number or full **5-digit frequency readout**. **RF Gain** and **Mic Gain** controls. SCAN and Dual Watch functions. Programmable quick access to a special **Truck** memory channel, LOCAL/DX attenuator, 4 + 1 memory channels and high quality Dynamic microphone with UP/DN/LOCK controls. Backlighted keypad. PA (Public Address) function.

Art. 05000320

Main Features

- > 10 Bands Programmable (all european countries)
- > AM/FM 4W
- > Extra large Amber Color LCD Display with S/Rf Meter
- > ESP COMPANDER (RX/TX Speech Processor)
- > TRUCK Memory Channel + 4 Memory Channels
- > LOC (RF Signal Attenuator) / PA function
- > RF GAIN and MIC GAIN controls
- > ANL (Automatic Noise Limiter) / SCAN / DW
- > EMG (Emergency Channels) quick access / LCR
- > Quick UP/DN channel selection
- > Soft type microphone curl cord
- > Dynamic MIC with UP/DN/LOCK controls

M-490EX PLUS

International Version, features 13 bands, 450 channels including 50 Alpha channels. Not available for sale or use in the EEC countries.

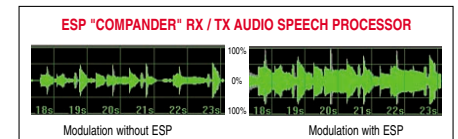



M-150 PLUS



FRONT SPEAKER DESIGN !

3-DIGIT DISPLAY

ANL / EMG / PA

ASQ / ROGER BEEP

CB 27 MHz PROGRAMMABLE MULTI-STANDARD MOBILE TRANSCEIVER

Multi-Standard CB mobile transceiver with **3W Front Speaker** design for the most efficient audio output, this radio is very suitable for trucks cabin, taxi cars and other noisy locations. 8 bands programmable for use in every European country. **3-digit band/channel display**, for clear indication of band ID code and channel number. **Roger Beep** and Auto (fixed) or manual Squelch, high efficiency new ANL (Automatic Noise Limiter). Slow or fast channel selection. Backlighting rubber keypad. PA (Public Address) function.

Art. 05000420

Main Features

- > 8 Bands Programmable (all European countries)
- > AM/FM 4W
- > 3-Digit Band/Channel LED Display
- > Manual or Auto (fixed) Squelch
- > EMG (Emergency Channels) quick access
- > ANL (Automatic Noise Limiter) / RB (Roger Beep)
- > Quick UP/DN channel selection
- > 3W high efficiency Front Speaker
- > Soft type microphone curl cord
- > 4-pin Mic Connector
- > PA (Public Address) circuit

M-150EX PLUS

International Version, features 11 bands, 450 channels including 50 Alpha channels. Not available for sale or use in the EEC countries.

**HIGH EFFICIENCY
3W MINI SPEAKER
M-150 PLUS / M-760 PLUS**



M-760 PLUS



FRONT SPEAKER DESIGN !

3-DIGIT DISPLAY

ANL / EMG / PA

ASQ / ROGER BEEP

CB 27 MHz PROGRAMMABLE MULTI-STANDARD MOBILE TRANSCEIVER

Multi-Standard CB mobile transceiver with **3W Front Speaker** design for the most efficient audio output, this radio is very suitable for trucks cabin, taxi cars and other noisy locations. 8 bands programmable for use in every European country. Wide backlighting amber color LCD display with digital S/Rf Meter. **Roger Beep** and Auto (fixed) Squelch, high efficiency new Automatic Noise Limiter, **Mic Gain** and **RF Gain** controls, Scan and Dual Watch. **ESP COMPANDER (RX/TX Speech Processor)** increases modulation level in transmission (Compressor) and audio modulation level in reception (Expander), with separate Compressor and Expander controls. Microphone with soft curl cord and UP/DN/LOCK controls. Slow or fast channel selection. Backlighting rubber keypad. PA (Public Address) function.

Art. 05000430

Main Features

- > 8 Bands Programmable (all European countries)
- > AM/FM 4W
- > Wide backlighting LCD with digital S/Rf Meter
- > ESP COMPANDER (RX/TX Speech Processor)
- > 3W high efficiency Front Speaker
- > EMG, ANL (Automatic Noise Limiter)
- > SCAN, DW (Dual Watch), LCR
- > UP/DOWN/LOCK controls also on microphone
- > Roger Beep, manual or Auto (fixed) Squelch
- > Quick UP/Quick DOWN channel selection
- > PA (Public Address) circuit
- > MIC Gain / RF Gain controls

M-760EX PLUS

International Version, features 11 bands, 450 channels including 50 Alpha channels. Not available for sale or use in the EEC countries.

ESP "COMPANDER" RX / TX AUDIO SPEECH PROCESSOR

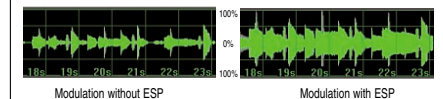



M-60 PLUS

NEW !



REMOTE PTT OPERATION

EXTERNAL MIC JACK

REMOTE PTT JACK

CB 27 MHz PROGRAMMABLE MULTI-STANDARD MOBILE TRANSCEIVER

SAFE DRIVE RADIO !

New Multi-Standard CB mobile transceiver, specifically designed for safe operation while driving. 9 bands programmable for use in every european country. **Blue color backlighted 3-digit LCD Display** indicates band ID, channel number and other functions enabled. Digital S/Rf Meter. **Remote PTT Control Box (RPT-1) jack** and **external Microphone (ESM-444 or ESM-555) jack**. Radio can be operated in PTT mode using the standard microphone or in the **SAFE DRIVE MODE** using the external microphone and the remote PTT control box (it may be attached on the steering wheel or to the shift lever).

Main Features

- > 9 Bands Programmable (all european countries) / AM/FM 4W
- > 3-Digit Band/Channel Blue Color backlighted LCD Display
- > Manual or ASQ Auto (fixed) Squelch
- > Digital S/Rf Meter
- > EMG (quick access to EMG Channels)
- > LCR (Last Used Channel Recall)
- > ANL (Automatic Noise Limiter)
- > External Microphone Jack
- > External Remote PTT Control Jack
- > Slow/Quick Channel Selector
- > Backlighted Silicon Rubber Keys
- > 4-pin Microphone with soft Curl Cord

Art. 05001130

OPTIONAL ACCESSORIES FOR M-60 PLUS AND M-899 VOX
(RPT-1 AND ESM-555 INCLUDED IN M-899 VOX)



RPT-1
Remote PTT Control with velcro strap and 2 mt cable with jack.
Art. 05006000

ESM-555
External Earset-Microphone with 1.4 mt cable and two jacks.
Art. 05006005

ESM-444
External Microphone (neck bracket type) with 1.4 mt cable and jack.
Art. 05006002

M-60EX PLUS
International Version, features 12 bands, 450 channels including 50 Alpha channels. Not available for sale or use in the EEC countries.

M-899 VOX

NEW !

COMPLETE WITH EXTERNAL EARSET-MICROPHONE AND REMOTE PTT CONTROL !

Art. 05001120



PTT OR VOX OPERATION

EXT EAR-MIC JACK

REMOTE PTT JACK

CB 27 MHz PROGRAMMABLE MULTI-STANDARD MOBILE TRANSCEIVER

SAFE DRIVE RADIO !

New advanced Multi-Standard CB mobile transceiver, specifically designed for safe operation while driving. 9 bands programmable for use in every european country. **Extra wide LCD Display** shows band ID, both channel number and full 5-digit frequency readout and every function enabled. **RF Gain** control, **VOX function with adjustable VOX Gain**. Remote PTT Control Box (RPT-1) and external Earset-Microphone (ESM-555) included.

3 OPERATING MODES FOR TRANSMITTING !

- PTT with Standard Mic
- PTT with Ext Mic and Remote PTT Control
- Full Handsfree with Ext Mic and VOX function

3 OPERATING MODES FOR RECEIVING !

- Listen from the built-in Speaker
- Listen from the Ext Earset
- Listen from an Ext Speaker (optional)

Main Features

- > 9 Bands Programmable (all european countries)
- > AM/FM 4W
- > Extra wide backlighted blue color LCD with CH and 5-digit frequency readout
- > Manual or Auto (fixed) Squelch
- > Digital S/Rf Meter, RF GAIN control
- > VOX function with adjustable VOX gain
- > EMG, LCR (Last Used Channel Recall)
- > ANL (Automatic Noise Limiter)
- > External Microphone/Earset Jacks
- > External Remote PTT Jack
- > Rotary Channel Selector
- > Backlighted Silicon Rubber Keys
- > Soft type Microphone Curl Cord

M-899EX VOX
Intern'l Version, with 14 bands, 450 channels and 50 Alpha channels. Not available for sale or use in the EEC countries.



RPT-1



ESM-555



M-550 POWER

12W AM-FM (**)

MIC GAIN / RF GAIN

ROGER BEEP / ANL

ECHO (*)



CB 27 MHz PROGRAMMABLE MULTI-STANDARD HIGH POWER MOBILE TRANSCEIVER

Multi-Standard CB mobile transceiver with **Analog S/R/F Meter**. 8 bands programmable for use in every European country. **Mic Gain** and **RF Gain** controls. **Roger Beep**, ANL (Automatic Noise Limiter) and EMG selector. Channel UP/DOWN and LOCK controls also on the microphone. Plug-in ECHO-550P **ECHO module** (*) (optional). Transmitter is using one Mitsubishi RF Power Mosfet type RD16HHF1. A classic and solid CB mobile radio.

Main Features

- > 8 Bands Programmable (all European countries)
- > AM/FM 4W
- > Analog S/R/F Meter
- > MIC GAIN control
- > RF GAIN control
- > EMG, ANL (Automatic Noise Limiter)
- > Roger Beep
- > ECHO function (with optional plug-in module ECHO-550P)
- > Quick UP/Quick DOWN channel selection
- > PA (Public Address) circuit
- > Soft type microphone curl cord

Art. 05000400

ECHO-550P

Plug-in digital ECHO module for M-550 POWER. Quick installation by simple connection to the ECHO connector on mainboard of the radio. Adjustable ECHO level and delay (repeat) time.

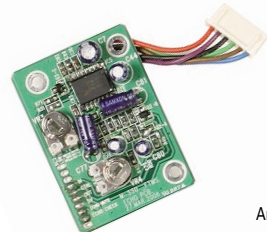

Art. 05002500

M-550EX POWER (**)

International Version, features 16 bands, 425 channels including 25 Alpha channels and 12W transmitter power. Not available for sale or use in the EEC countries.

BKT-DIN-S10

DIN MOUNT



DIN MOUNT CAR BRACKET FOR CB RADIOS

DIN size mount kit for car, truck or boat dashboard installation of CB radios, complete with mounting brackets, hardware and ABS front side cover. Installation can be made without drilling any hole. For models M-120 PLUS, M-130 PLUS, M-799 PLUS, M-795 POWER and similar.

Art. 80002705

BKT-DIN-S90

DIN MOUNT



DIN MOUNT CAR BRACKET FOR CB RADIOS

DIN size mount kit for car, truck or boat dashboard installation of CB radios, complete with mounting brackets, hardware and ABS front side cover. Installation can be made without drilling any hole. For models M-490 PLUS, M-550 POWER, M-150 PLUS, M-760 PLUS, M-495 POWER, M-899 VOX and similar.

Art. 80002700

MULTISTANDARD CB RADIOS - EUROPEAN CE R&TTE VERSIONS - BAND ID / CHANNEL / MODE / POWER TABLE

BAND ID	COUNTRY	FM	AM	FREQ. RANGE	REMARKS
E1 / I0 / 01	ITALY / SPAIN	40CH / 4W	40CH / 4W	26.965 - 27.405	
I2 / 02	ITALY	36CH / 4W	36CH / 4W	26.855 - 27.265	
DE / 03	GERMANY	80CH / 4W	12CH / 1W	26.565 - 27.405 27.005 - 27.135	
D2 / 04	GERMANY	40CH / 4W	12CH / 1W	26.965 - 27.405 27.005 - 27.135	
EU / 05	EUROPE / FRANCE	40CH / 4W	40CH / 1W	26.965 - 27.405	
CE / 06	CEPT	40CH / 4W		26.965 - 27.405	
E1 / SP / 01	SPAIN	40CH / 4W	40CH / 4W	26.965 - 27.405	
EU / FR / 05	FRANCE	40CH / 4W	40CH / 1W	26.965 - 27.405	
UK / 07	UK	40CH / 4W		27.60125 - 27.99125	UK FREQUENCIES
		40CH / 4W		26.965 - 27.405	CEPT FREQUENCIES
PL / 08	POLAND	40CH / 4W	40CH / 4W	26.960 - 27.400	POLISH FREQUENCIES
Pd	POLAND	40CH / 4W	40CH / 1W	26.960 - 27.400	POLISH FREQUENCIES

MULTISTANDARD CB RADIOS - INTERNATIONAL VERSIONS - BAND ID / CHANNEL / MODE / POWER TABLE

BAND ID	COUNTRY	AM / FM	FREQ. RANGE	REMARKS
RU	INTERNATIONAL	450CH	25.615 - 30.105	LIMITED TO 400CH OR 200CH IN SOME MODELS
PO	INTERNATIONAL	450CH	25.610 - 30.100	LIMITED TO 400CH OR 200CH IN SOME MODELS
PC	INTERNATIONAL	50CH	25.645 - 29.895	
S	INTERNATIONAL	120CH	26.515 - 27.855	3 CENTRAL CB BANDS (-40 / 40 / +40)



M-795 POWER

20W AM-FM ! (*)

ESP RX-TX SPEECH PROCESSOR

DYNAMIC MIC

ASQ / EMG / SCAN

DUAL WATCH / LCR



CB 27 MHz PROGRAMMABLE MULTI-STANDARD HIGH POWER MOBILE TRANSCEIVER

Multi-Standard CB mobile transceiver. 10 bands programmable for use in every european country. Wide backlighted amber color LCD display with digital S/RF Meter, shows band ID code, channel number and every other enabled function. Auto (fixed) or manual Squelch. Digital **ESP COMPANDER (RX/TX Speech Processor)** increases modulation level in transmission (Compressor) and audio modulation level in reception (Expander). SCAN and Dual Watch functions. high quality Dynamic microphone with UP/DN/LOCK controls. Backlighted keypad. Transmitter is using one Mitsubishi RF Power Mosfet type RD16HHF1.

Art. 05001100

Main Features

- > 8 Bands Programmable (all european countries)
- > AM/FM 4W
- > Backlighted LCD Display (orange color) with Digital S/RF Meter
- > ESP COMPANDER (RX/TX Speech Processor)
- > Manual or Auto (fixed) Squelch
- > Scan, Dual Watch, EMG, LCR (Last Used Channel Recall), ANL
- > High quality Dynamic Microphone with UP/DN/LOCK controls
- > Quick UP/Quick DOWN channel selection



Large size heatsink provides heat dissipation for the high power Mosfet RD16HHF1

ESP "COMPANDER" RX / TX AUDIO SPEECH PROCESSOR

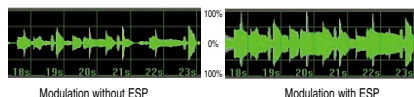

M-795EX POWER (*)

International Version, features 13 bands, 450 channels including 50 Alpha channels and 20W transmitter power. Not available for sale or use in the EEC countries.

M-495 POWER

20W AM-FM ! (*)

FREQUENCY READOUT !

50 CTCSS TONES

ESP RX-TX SPEECH PROCESSOR

DYNAMIC MIC

1 + 4 MEMORY CH

RF GAIN / MIC GAIN



CB 27 MHz PROGRAMMABLE MULTI-STANDARD HIGH POWER MOBILE TRANSCEIVER

Advanced Multi-Standard CB mobile transceiver. 10 bands programmable for use in every european country. **50 CTCSS tones** (FM). Digital **ESP COMPANDER (RX/TX Speech Processor)** increases modulation level in transmission (Compressor) and audio modulation level in reception (Expander). Wide LCD Display shows channel number or full **5-digit frequency readout**. **RF Gain** and **Mic Gain** controls, **Roger Beep** tone. Programmable quick access to a special **Truck** memory channel, LOCAL/DX attenuator, 4 + 1 memory channels and high quality Dynamic microphone with UP/DN/LOCK controls. Backlighted keypad. PA (Public Address) function.

Art. 05001105

Main Features

- > 10 Bands Programmable (all european countries) / AM/FM 4W
- > Extra large Amber Color LCD Display with S/RF Meter
- > ESP COMPANDER (RX/TX Speech Processor)
- > 50 CTCSS tones (FM), Manual or Auto (fixed) Squelch, Roger Beep Tone
- > TRUCK Memory Channel + 4 Memory Channels
- > LOC (RF Signal Attenuator) / PA function / ANL / SCAN / DW
- > RF GAIN and MIC GAIN controls
- > EMG (Emergency Channels) quick access / LCR
- > Quick UP/DN channel selection
- > Dynamic MIC with UP/DN/LOCK controls



Large size heatsink provides heat dissipation for the high power Mosfet RD16HHF1

ESP "COMPANDER" RX / TX AUDIO SPEECH PROCESSOR

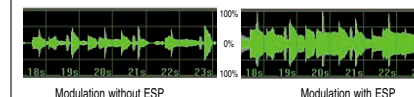

M-495EX POWER (*)

International Version, features 13 bands, 450 channels including 50 Alpha channels and 20W transmitter power. Not available for sale or use in the EEC countries.



H-510 PLUS

AM 4W



H-512 PLUS

AM-FM 4W

CB 27 MHz PROGRAMMABLE MULTI-STANDARD HANDHELD TRANSCEIVERS

CB Multi-Standard programmable handheld radios with advanced hardware and software design. Very compact and light case (185 gr. only). Backlighted LCD display with **3-digit band/channel reading** and **battery level meter**. AM mode (H-510 PLUS) and AM/FM modes (H-512 PLUS). Hi-Low transmitter power for battery saving and **mobile car adaptor** (optional) compatible, powered with 6 x Alkaline or Ni-MH batteries.

Art. 05002910 INTEK H-510 PLUS

Art. 05002912 INTEK H-512 PLUS

Main Features

- > 5 Bands Programm. (all europe countries) H-510 PLUS
- > 8 Bands Programm. (all europe countries) H-512 PLUS
- > Adjustable RF transmitter power 4W / 1W
- > 3-Digit Band/CH Green Color backlighted LCD Display
- > Digital 4-bar battery level indicator
- > LOCK, quick UP/DOWN channel selection
- > Manual or Auto (fixed) Squelch
- > External earset-microphone jack
- > TX LED indicator
- > BNC rubber flexible antenna

See page 25 for more optional accessories for H-510/512/520 PLUS

H-510EX PLUS
International Version, features 7 bands, 200 channels.
Not available for sale or use in the EEC countries.

H-512EX PLUS
International Version, features 10 bands, 200 channels.
Not available for sale or use in the EEC countries.



H-520 PLUS

AM-FM 4W

WORLD BEST CB HANDHELD + MOBILE RADIO !

ESP RX-TX SPEECH PROCESSOR

DIGITAL S/R/F METER

CB 27 MHz PROGRAMMABLE MULTI-STANDARD HANDHELD TRANSCEIVER

CB Multi-Standard programmable handheld radio with advanced features. Compact and light case, backlighted **5-lines 1.8" LCD display**, **digital S/R/F meter** and **both CH number and 5-digit frequency readout**. **ESP (RX and TX Speech Processor)**, 8 memory channels, adjustable RF output power (3 levels) and much more. **Full set includes battery charger and mobile car adaptor (CAR-520)**. Powered with 6 x Alkaline or Ni-MH batteries. The most advanced and complete CB handheld radio ever made.

Art. 05003000

Main Features

- > 8 Bands Programmable (all european countries)
- > AM/FM 4W
- > 5-lines 1.8" backlighted LCD display
- > Channel and 5-digit full frequency readout
- > Adjustable RF output power 4W/1W/100mW
- > ESP COMPANDER (RX/TX Speech Processor)
- > Digital S/R/F Meter and 4-bar Battery Meter
- > LOCK, EMG, SCAN, Dual Watch, LCR
- > Quick UP/DOWN channel selection
- > 8 memory channels
- > Manual or Auto (fixed) Squelch
- > External earset-microphone jack
- > BNC rubber flexible antenna

5-LINES EXTRA LARGE 1.8" LIGHTED LCD / CH + FULL FREQUENCY READOUT

Full set includes radio, antenna, strap, mobile car adaptor and 230V charger.



H-520EX PLUS
International Version, features 11 bands, 450 channels including 50 Alpha channels. Not available for sale or use in the EEC countries.

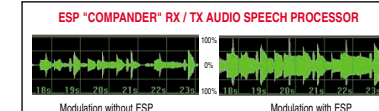

CAR-520

MOBILE CAR ADAPTOR

Converts handheld CB radios into mobile units. 12V power from car electric system through lighter adaptor. SO-239 RF antenna connector. For H-510 / H-512 / H-520.

Art. 05005000



CHGKIT-500

CHARGING KIT

This kit includes 6 x AA 1500mAh Ni-MH rechargeable batteries and the 230VAC charger. For H-510 / H-512.

Art. 05005030



LC-520

SOFT CARRYING CASE

Soft carrying case, with PVC window. For H-510 / H-512 / H-520.

Art. 05005008



CB MONITOR - ROAD WATCHER !

NEW !

COMPLETE SET INCLUDES
CB MONITOR WITH 12V CAR PLUG AND
QUICK MOUNT MAGNET ANTENNA !

CBM-450

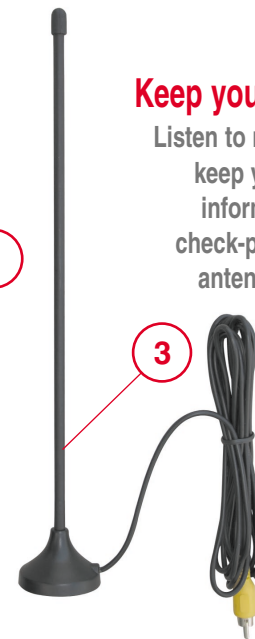

Real time information while driving !
Keep yourself informed on what's going on the road !
Listen to radio communication from trucks and other vehicles and keep yourself informed on what's going on the road. Real time information on traffic condition, traffic jams, accidents, police check-points, speed controls, etc. Comes complete with magnet antenna and 12V car lighter adaptor, no installation required.

NO LICENSE ! NO FEES ! NO OPERATING COST !
COMPLETE KIT ! NO INSTALLATION REQUIRED !

Complete set includes CB Monitor-Receiver (CBM-450) ① with 12VDC Lighter Adaptor ② and quick mount CB Magnet Antenna (MAG-1330) ③ with 4 meter cable and connector.

27 MHz PROGRAMMABLE MULTI-STANDARD MOBILE CB MONITOR (ROAD WATCHER)

CB Monitor (receiver), comes complete with a quick-mount CB Magnet Antenna and with a 12V Car Lighter Adaptor. No installation is required, radio can be used immediately after purchase. **8 bands programmable for use in every european country**, AM/FM mode, receives all CB channels. EMG key for immediate access to CH9/CH19 which are the channels used by all truck drivers. OFF-ON/Volume control and AS/SQL for manual or automatic (fixed) squelch control. UP/Down knobs for slow or fast channel selection. ANL (Automatic Noise Limiter) to cut pulse noise from motorcycles or car engines. **Wide blue color backlit LCD display**, shows channel number, band ID and other enabled functions. Digital S-Meter shows strenght of received signal. Very user friendly operation. Built-in 3W speaker for clear strong audio. Backlighted function keys.

Art. 05100000

Main Features

- > 8 Bands Programmable (all european countries)
- > AM/FM
- > EMG key for quick access to trucks used channels (CH9/CH19)
- > ANL (Automatic Noise Limiter) cuts pulse noises from motorcycles or cars engines
- > AS/SQL Squelch control with manual or automatic (fixed) setting
- > Blue color backlit LCD with Signal Meter and 3-Digit for band/channel number
- > UP/Down keys for slow or fast channel selection
- > Magnet Mount Antenna with 30cm Whip and 4 meter cable
- > 12V Car Lighter Adaptor for connecting to the car lighter socket
- > Dimension of receiver : mm 114 x 45 x 165 / Weight : 400 gr.

CB MONITOR
27 MHZ CITIZEN BAND MONITOR
(ROAD WATCHER)

HR-2800

NEW !

**AMATEUR RADIO
10-METER BAND**

AM-FM 20W

28.000 - 29.700 KHz in 5 KHz Steps

ESP RX-TX SPEECH PROCESSOR

12.0 - 32.0 VDC POWER SUPPLY



Main Features

- > Frequency range 28.000 - 29.700 MHz HF 10 Meter Band AM/FM
- > Backlighted LCD Display (amber color) with 5-digit frequency readout
- > ESP COMPANDER (RX/TX modulation speech processor)
- > Digital S/Rf Meter, RG Gain control, Mic Gain control
- > Scan, Dual Watch, EMG, LCR, ANL, LOC/DX
- > Dynamic Microphone with UP/DOWN/LOCK controls
- > Quick UP/Quick DOWN frequency selection
- > PA (Public Address) circuit
- > 4 + 1 Memory Channels
- > Wide DC Voltage input range (12.0-32.0VDC) with built-in electronic voltage regulator (DC-DC Converter)
- > Mitsubishi RD16HHF1 Mosfet Power RF Transistor
- > AS/SQL (manual or automatic (fixed) Squelch control)

28 MHz AM-FM 20W AMATEUR RADIO HF TRANSCEIVER

Amateur radio HF mobile transceiver, covers the 28 MHz frequency band reserved to Amateur Radio communication. Frequency range 28.000-29.700 KHz in 5 KHz frequency steps. **Transmitter RF power 20W max in AM and FM modes.** Digital **ESP (RX and TX Electronic Speech Processor)** compresses modulation level in transmission (Compressor) and expands audio modulation in reception (Expander). **Large backlighted amber color LCD Display** with digital S/Rf Meter, shows full 5-digit frequency readout. **RF Gain** and **Mic Gain** controls. Programmable 5 + 1 memory channels, LOCAL/DX RF attenuator, manual and automatic (fixed) Squelch control. ANL (Automatic Noise Limiter), SCAN and DW (Dual Watch) functions. High quality Dynamic microphone with UP/DN frequency and LOCK controls. **Radio can be powered with 12.0VDC minimum to 32.0VDC maximum, with built-in electronic voltage regulator.**



Large size heatsink provides heat dissipation for the high power Mosfet RD16HHF1



High quality Dynamic Microphone with UP/DN frequency control and LOCK

Art. 13000000

28.000 - 29.700 KHz AM/FM 20W

HR-2800EX International Version, features additional 11 CB bands (all european and international CB bands) frequency range 25.610-30.105 KHz. Not available for sale or use in the EEC countries.

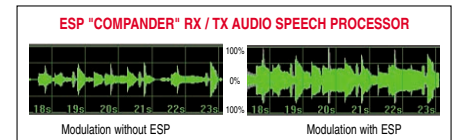

www.intek-radios.com

New products information, specifications, user manuals, downloads and more

see page 61 for "LAST MINUTE NEW PRODUCTS" !

HAM RADIOS

HF, VHF, UHF AMATEUR RADIO TRANSCEIVERS



HR-5500

NEW !

**AMATEUR RADIO
10-METER BAND**



PC PROGRAMMABLE

7-DIGIT FREQUENCY DISPLAY

BUILT-IN SWR METER

ADJUSTABLE TX RF POWER

ROGER BEEP + ECHO

12 W AM/CW

40 W FM

40 W SSB

28 MHz AM-FM-SSB-CW AMATEUR RADIO HF TRANSCEIVER

Amateur radio HF mobile transceiver, covers the 28 MHz frequency band reserved to Amateur Radio communication. Frequency range 28.000-29.700 KHz, adjustable frequency steps (10Hz, 100Hz, 1KHz or 10KHz). **Adjustable TX RF power, 12W max AM/CW, 40W max FM/SSB.** Multiple **Clarifier** operating modes. Flexible menu functions and PC programming software to fit radio to each operator's demand. **Large backlitged amber color LCD Display** with digital S/RF Meter, shows full 7-digit frequency readout, plus 2-digit LED display. **RF Gain, RF Power, Clarifier, Dual Watch, Scan, TOT, NB/ANL, LOCK, LCD Off, +10KHz, SQ/ASQ** functions. High quality Dynamic microphone with UP/DN frequency and AQ controls. **DC Voltage** display function. SWR protection and power supplied voltage protection. Software allows to program frequency range limits, frequency channels, Mic Gain limits, factory reset function, CW side tone frequency and volume, RB holding time and much more.

Art. 13000020

Main Features

- > Frequency range 28.000 - 29.700 MHz HF 10 Meter Band AM/FM/SSB/CW
- > Frequency Range 25.615 - 30.105 MHz (HR-5500EX version only)
- > Backlitged LCD Display (amber color) with 7-digit frequency readout
- > 2-Digit Channel Number readout
- > 6 Frequency Bands, 60 Channels (programmable) in each band
- > RF Power max 12W AM/CW, 40W FM, 40W SSB
- > Digital S/RF Meter, RG Gain control, RF Power control
- > Scan/SC List, Dual Watch, EMG, RB, NB/ANL, LOCK, LCD Off, TOT, HI-Cut
- > Dynamic Microphone with UP/DOWN/AQ (Auto Squelch) controls
- > Quick UP/Quick DOWN frequency selection
- > PA (Public Address) circuit
- > AS/SQL (manual or automatic Squelch control)
- > Radio is fully PC programmable (with optional PC Interface Cable)
- > Antenna Connector UHF SO239
- > Temperature Range -15/+50 °C
- > Input Voltage 13.8V (15.9V max / 11.7V min) - 9A max at 40W SSB PEP
- > Dimension : cm 28 x 25 x 6 / Weight : kg 2.8

HR-5500EX International Version, includes all CB bands and frequency range 25.610-30.105 KHz. Not available for sale or use in the EEC countries.

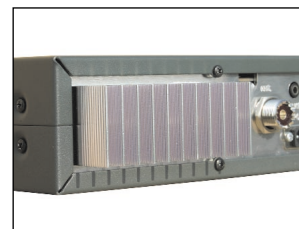
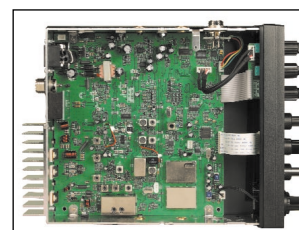

D-056



PC INTERFACE CABLE (USB TYPE)

USB type PC interface cable for HR-5500.

Art. 13000030

**FREE SOFTWARE DOWNLOAD FROM
www.intek-radios.com**

**DESK TYPE REGULATED
POWER SUPPLIES
FOR HIGH POWER HF RADIOS**



SPA-8100 13.8V 10A MAX
see page 30



SPA-8230 13.8V 23A MAX
see page 30



SPS-8400 3-15V 40A MAX
see page 31



KT-370EE

144-146 MHz FM 5W

AMATEUR RADIO 144 MHz VHF FM
TRANSCEIVER 80CH 5W PC PROGRAMMABLE

VHF FM handheld transceiver, VFO + 80 channels, PC programmable (optional program kit), compact size, professional construction with **diecast aluminum chassis. 5W RF Mosfet transmitter.** VOX, simplex or semi-duplex. 50 CTCSS / 106 DCS Tones, **selectable narrow wide FM mode.** Programmable by PC or directly by keypad. Backlighted dot matrix LCD display with digital S/RF meter. SMA antenna.

Art. 25002280

Main Features

- > Frequency range 144-146 MHz (136-175 MHz) / VFO + 80 channel / 5W-1W
- > Backlighted dot matrix LCD
- > Memory channel and 8-digit frequency readout
- > Digital S/RF/Battery meter
- > LOCK, CALL, TOT
- > PC programmable functions : ch / frequency / LOCK / TX power / Squelch level / 50 x CTCSS and 106 x DCS tones encoder/decoder / VOX sensitivity / SCAN / frequency step / TOT / keypad program tone / LCD backlight
- > Steps 5/6.25/10/12.5/25 KHz



PC PROGRAMMABLE

Package includes antenna, 1200mAh battery pack and 230VAC quick desk type charger.



CDKT-1

PROGRAMMING KIT

PC interface cable and software CD for KT-370EE, KT-380EE and KT-900EE.

Art. 26002360



KT-380EE

144-146 MHz FM 5W

AMATEUR RADIO 144 MHz VHF FM
TRANSCEIVER 80CH 5W PC PROGRAMMABLE

VFO + 80 channels, PC programmable (optional progr. kit), **diecast aluminum chassis. 5W RF power Mosfet transmitter.** VOX, simplex or semi-duplex. 50 CTCSS / 106 DCS Tones, selectable freq. step. **Dial multi-function knob.** Programmable by PC or by keypad. Backlighted dot matrix LCD display with digital S/RF meter. SMA antenna.

Art. 25002300

Main Features

- > Freq. range 144-146 MHz 5W (136-175 MHz) / VFO + 80 CH
- > Backlighted dot matrix LCD
- > Memory channel and 8-digit freq. readout
- > Adjustable TX power 5W/1W
- > Digital S/RF/Battery meter
- > LOCK, CALL, TOT
- > PC programmable functions : ch / frequency / keypad LOCK manual or automatic / TX power / Squelch level / 50 CTCSS and 106 DCS tones encoder/decoder / VOX sensitivity / SCAN / frequency step / TOT / keypad program tone / LCD backlight
- > Steps 5/6.25/10/12.5/25 KHz



PC PROGRAMMABLE

Package includes antenna, 1200mAh battery pack and 230VAC quick desk type charger.



NEW !

CDKT-1-USB

PROGRAMMING KIT
WITH USB CABLE

PC interface USB cable and software CD for KT-370EE, KT-380EE and KT-900EE.

Art. 26005757



KT-900EE

DUAL BAND VHF-UHF FM

144-146 / 430-440 MHz 5W

CROSS BAND OPERATION

PC PROGRAMMABLE

AMATEUR RADIO 144-430 MHz
2-METER / 70-cm BANDS
VHF-UHF TRANSCEIVER 199CH
5W PC PROGRAMMABLE

VHF-UHF FM Dual Band Amateur Radio transceiver, 199 channels, PC programmable (optional program kit), professional construction with **diecast aluminum chassis. 5W RF power Mosfet transmitter.** VOX, 50 CTCSS / 106 DCS, **selectable narrow wide FM mode,** selectable frequency step. **Dial multi-function knob.** Programmable by PC or by keypad. Backlighted dot matrix LCD display with digital S/RF meter. SMA antenna.

Art. 25002305

Main Features

- > Frequency range 144-146 MHz (136-174 MHz) / 430-440 (400-470 MHz) / 199CH / 5W
- > Dual CH / Dual freq.readout
- > Adjustable TX power 5-4-1W
- > Digital S/RF/Battery meter
- > CALL, TOT (Time Out Timer)
- > 1750 Hz Repeater Tone
- > PC programmable functions : ch / frequency / keypad lock manual or auto / TX power / Squelch level / 50 CTCSS and 106 DCS tones enc/dec / VOX sensitivity / SCAN / frequency step / TOT / keypad program tone / ANI / Channel Naming / LCD backlighting
- > Steps 5/6.25/10/12.5/25 KHz



Package includes antenna, 1600mAh battery pack and 230VAC quick desk type charger.

See previous and following pages for more optional accessories



KT-930EE

NEW !

2200mAh BATTERY PACK !

EXTRA RUGGED HANDHELD !

FREE SOFTWARE DOWNLOAD

144-146 MHz 5W / 430-440 MHz 4W

AMATEUR RADIO 144-430 MHz 2-METER / 70-cm DUAL BAND VHF-UHF TRANSCEIVER 128CH 5W VHF / 4W UHF PC PROGRAMMABLE

Extra rugged and solid VHF-UHF FM Amateur Radio transceiver, Dual Band, Dual Frequency, Dual Display and Dual Stand-by. Work mode : V-U, U-V, V-V, U-U., 128 channels, PC programmable (optional PC Cable). Professional construction with diecast aluminum chassis. 5W/4W RF power (Hi/Mid/Low selectable). Extra high capacity Li-Ion Battery (2200 mAh), VOX, 50 CTCSS / 105 DCS, **selectable Wide/Narrow mode**. Multi display function, multi function Scan. Selectable frequency step (5/6.25/10/12.5/25/37.5/50/100 KHz). FM Radio (88-108 MHz). Offset frequency setting (0-69.950 MHz). Backlighted dot matrix LCD display with digital S/RF meter. Freq. shift direction setting, Key Lock, Busy Channel Lockout, Squelch tail elimination, **Power-on password**, Wire Clone, Power-on message display (battery voltage/full screen/other message). SMA antenna.

Art. 25002430

Main Features

- > Freq. range 144-146 MHz (136-174 MHz) 5W / 430-440 (400-470 MHz) 4W / 128CH
- > Dual Band, Dual Frequency, Dual Display, Dual stand-by
- > Dot Matrix LCD Display with digital S/RF Meter
- > 50 CTCSS / 105 DCS tones / Selectable Wide/Narrow mode
- > Steps 5/6.25/10/12.5/25/37.5/50/100 KHz
- > FM Radio 88-108 MHz / Offset freq. setting 0-69.950 MHz
- > BCL, Squelch Tail Elimination, Wire Clone, 1750 Hz Repeater Tone
- > Power-on Password / Power-on Message Display
- > PC programmable (with optional PC cable)



Full set includes main unit, SMA antenna, 2200mAh battery pack and 230VAC desk type quick charger.

D-930

PC INTERFACE CABLE (USB TYPE)
USB type PC interface cable for KT-930EE.

Art. 25002440

KT-950EE

NEW !

REAL POCKET SIZE DUAL BAND VHF/UHF !

144-146 / 430-440 FM 2W

FREE SOFTWARE DOWNLOAD

AMATEUR RADIO 144-430 MHz 2-METER / 70-cm DUAL BAND VHF-UHF TRANSCEIVER 99CH 2W PC PROGRAMMABLE

Pocket size VHF-UHF FM Dual Band Amateur Radio transceiver, 99 channels, PC programmable (optional PC cable), professional construction with diecast aluminum chassis. Selectable RF power (Hi-Low). Adjustable Squelch level, VOX, Dual Watch, 50 CTCSS / 106 DCS, selectable Wide/Narrow mode, selectable frequency step (5/6.25/10/12.5/25 KHz), Offset, Shift Repeater, TOT, Scan, Busy Channel Lockout, Priority Channel, LOCK. FM Radio (88-108 MHz). **Dial multi-function knob**. Backlighted amber color LCD display with digital S/RF meter. SMA antenna.

Art. 25002450



Main Features

- > Freq. range 144-146 MHz (136-174 MHz) / 430-440 (400-470 MHz) / 99CH / 2W
- > Dual Band, Dual Freq., Dual Display
- > Digital S/RF/Battery meter
- > CALL, TOT, Scan, BCL, LOCK
- > VOX, Dual Watch, Shift Repeater
- > Repeater Sound Response
- > 1750 Hz Repeater Tone
- > Steps 5/6.25/10/12.5/25 KHz
- > Adjustable Squelch Level
- > Selectable RF Power (Hi-Low)
- > 50 CTCSS / 106 DCS
- > Selectable Wide/Narrow mode
- > Busy Channel Lockout, Offset
- > Priority Channel, RX Code / TX Code
- > FM Radio 88-108 MHz
- > Emergency Alarm, Battery Save
- > Tail Tone Elimination
- > PC programm. (with optional PC cable)

FREE SOFTWARE DOWNLOAD
www.intek-radios.com



DESK CHARGER & CAR CHARGER, ALL INCLUDED !

D-950

PC INTERFACE CABLE (USB TYPE)
USB type PC interface cable for KT-950EE.

Art. 25002460

LS-18

BATTERY PACK

Li-Ion 7.2V 1200mAh rechargeable battery pack (original spare part) for KT-370EE.

Art. 25002340



AT-15

BATTERY PACK

Li-Ion 7.2V 1200mAh rechargeable battery pack (original spare part) for "MT" / "DX" series.

Art. 25002310



LP-18

BATTERY PACK

High capacity Li-Poly 7.4V 1800mAh rechargeable battery pack for "MT" / "DX" series.

Art. 25002312



AT-95

BATTERY PACK

High capacity Li-Ion 7.4V 1 600mAh rechargeable battery pack for KT-900EE.

Art. 25002351



LN-2200K

BATTERY PACK

Li-Ion 7.2V 2200mAh rechargeable battery pack (original spare part) for KT-930EE.

Art. 25002436



LN-950

BATTERY PACK

Li-Ion 3.7V 1500mAh rechargeable battery pack (original spare part) for KT-950EE.

Art. 25002456



EM-950

EARSET-MIC

Earset-microphone with soft silicon hear hanger and PTT Key for KT-950EE.

Art. 25002458





PROFESSIONAL RADIOS VHF / UHF / PMR446

"MT" SERIES

VHF 136-175 MHz FM 5W

UHF 400-470 MHz FM 4W

PMR446 16CH FM 0.5W



PROFESSIONAL PC PROGRAMMABLE HANDHELD TRANSCEIVER

Professional FM 16 channels handheld transceiver with solid diecast aluminum chassis, suitable for business and professional use. Fully PC programmable (with optional programming kit). Mosfet transmitter, CTCSS, DCS, Time Out Timer, SCAN. Waterproof earset-microphone jack. Full set includes main unit, 7.2V Li-Ion 1200mAh battery pack and 230VAC desk type automatic quick charger. Rubber flexible SMA antenna (fixed antenna in PMR446 version).

Available versions :

MT-174S VHF FM 5W
MT-460S UHF FM 4W
MT-446EX PMR446 FM 0.5W

Main Features

- > 16 channels (factory pre-programmed)
- > 5W (VHF), 4W (UHF), 0.5W (PMR446) RF Mosfet transmitter
- > Adjustable Hi-Low transmitter power
- > 50 CTCSS tones (Encoder/Decoder)
- > 106 DCS tones (Encoder/Decoder)
- > Time-Out-Timer / Low batt. warning
- > Dual color RX/TX LED indicator
- > PC programmable functions : channel / frequency / TX RF output power / Squelch threshold level / CTCSS (Encoder/Decoder) and DCS (Encoder/Decoder) tone / SCAN / Time-Out-Timer

PC PROGRAMMABLE



Full set includes main unit, antenna, AT-15 1200mAh battery pack and 230VAC quick desk type charger.

Art. 26005305 MT-174S (VHF 136-175 MHz)
 Art. 26005355 MT-460S (UHF 400-470 MHz)
 Art. 26005530 MT-446EX (PMR446 16CH)

See previous and following pages for more optional accessories

"DX" SERIES

VHF 136-175 MHz FM 5W

PC PROGRAMMABLE

UHF 400-470 MHz FM 4W



PROFESSIONAL PC PROGRAMMABLE HANDHELD TRANSCEIVER

FM handheld 80 channels professional transceiver, **PC programmable** (with optional programming kit), **diecast aluminum chassis**. **5W RF power Mosfet transmitter** with minimum current drain. VOX function, simplex or semi-duplex operation. CTCSS and DCS, selectable frequency step. **Dial multi-function knob**. Programmable by PC or direct programming by keypad. Full set includes electronic desk type rapid charger. Backlighted **dot matrix LCD display** with digital S/R/F meter. Rubber flexible SMA antenna.

Available versions :

DX-174S VHF FM 5W Art. 26005310
DX-460S UHF FM 4W Art. 26005364

Main Features

- > 80 channels simplex or semi-duplex
- > 5W (VHF), 4W (UHF) / Hi-Low RF power
- > Channel and 8-digit frequency readout
- > Digital S/R/F/Battery meter / LOCK, CALL, TOT
- > PC programmable functions : channel / frequency / LOCK / TX power / Squelch level / 50 CTCSS and 106 DCS enc - dec / VOX sens. / SCAN / freq. step / TOT / keypad tone / LCD backlight
- > Steps 5/6.25/10/12.5/25 KHz



Full set includes main unit, antenna, AT-15 1200mAh battery pack and quick desk type charger.

CDMD-1 PROGRAMMING KIT

PC interface cable and software CD for all "MT" and "DX" radios.



Art. 26005482

CDHH-1 PROGRAMMING KIT

PC interface cable and software CD for all "HT" and "HX" radios.



Art. 26005690



"HT" SERIES

VHF 136-175 MHz FM 5W

UHF 400-470 MHz FM 4W

PMR446 199CH FM 0.5W

199 CHANNELS / ANI
SCRAMBLER (*)

PROFESSIONAL PC PROGRAMMABLE HANDHELD TRANSCEIVER

Professional FM 199 channels handheld transceiver with diecast aluminum chassis. PC programmable (with optional program kit) or direct keypad programmable. Mosfet transmitter, CTCSS, DCS, Time Out Timer, Auto Scan Priority Channels, VOX, Wire Clone, **ANI function, Channels Naming**, Busy Channel Lockout. **Scrambler** function (except mod. HT-446S). Waterproof earset-microphone jack. Full set includes main unit, 7.4V Li-Ion 1200mAh battery pack and 230VAC desk type quick charger. User friendly for 4-key pad. Rubber flexible SMA antenna (fixed antenna in PMR446 versions). Dot matrix backlighted LCD display.

Available versions :

HT-174S	VHF FM 5W	Art. 26005651
HT-460S	UHF FM 4W	Art. 26005652
HT-446S	PMR446 FM 0.5W (without Scrambler) (*)	Art. 26005650
HT-446S/SCR	PMR446 FM 0.5W	Art. 26005660

Main Features

- > 199CH / 5W (VHF), 4W (UHF), 0.5W (PMR446) RF Mosfet transmitter
- > Adjustable Hi-Low transmitter power
- > 50 CTCSS tones (Encoder/Decoder) / 106 DCS tones (Encoder/Decoder)
- > Wide/narrow bandwidth selectable (HT-174S / HT-460S)
- > SCRAMBLER (excluding model HT-446S) / TOT / Low battery
- > VOX, SCAN, Priority, Wire Cloning, Power Save, ANI, Channel Naming, adjustable Squelch, Busy Channel Lockout, Emergency Alert
- > Fully PC programmable (with optional program kit) or direct by keypad

Full set includes main unit, SMA antenna, AT-68 1200mAh battery pack and 230VAC desk type quick charger.

See previous and following pages for more optional accessories



PC PROGRAMMABLE

"HX" SERIES

VHF 136-175 MHz FM 5W

UHF 400-470 MHz FM 4W

PMR446 199CH FM 0.5W

199 CHANNELS / ANI
SCRAMBLER

PROFESSIONAL PC PROGRAMMABLE HANDHELD TRANSCEIVER

Professional FM 199 channels handheld transceiver, solid diecast aluminum chassis. Fully PC programmable (with optional programming kit) or direct keypad programmable. Full size keypad. Mosfet transmitter, CTCSS, DCS, Time Out Timer, Auto Scan Priority Channels, VOX, Wire Clone, **ANI function, Channels Naming**, Busy Channel Lockout. **Scrambler** function. Waterproof earset-microphone jack. Full set includes main unit, 7.4V Li-Ion 1200mAh battery pack and 230VAC desk type quick charger. Rubber flexible SMA antenna (fixed antenna in PMR446 version). Dot matrix backlighted LCD display.

Available versions :

HX-174S/SCR	VHF FM 5W	Art. 26005671
HX-460S/SCR	UHF FM 4W	Art. 26005672
HX-446S/SCR	PMR446 FM 0.5W	Art. 26005670

Main Features

- > 199CH / 5W (VHF), 4W (UHF), 0.5W (PMR446) RF Mosfet transmitter
- > Adjustable Hi-Low transmitter power
- > 50 CTCSS tones (Encoder/Decoder)
- > 106 DCS tones (Encoder/Decoder)
- > Wide/narrow bandwidth selectable (HX-174S / HX-460S)
- > VOX, SCAN, Priority, Wire Cloning, Power Save, ANI, Channel Naming, adjustable Squelch level, Busy Channel Lockout, Emergency Alert, SCRAMBLER / TOT / Low battery
- > Fully PC programmable (with optional program kit) or direct by keypad
- > Full size 16-key pad

Full set includes main unit, SMA antenna, AT-68 1200mAh battery pack and 230VAC desk type quick charger.

See previous and following pages for more optional accessories



PC PROGRAMMABLE

CDMD-1-USB PROGRAMMING KIT WITH USB CABLE

PC interface USB cable and software CD for all "MT" and "DX" radios.



Art. 26005758

CDHH-1-USB PROGRAMMING KIT WITH USB CABLE

PC interface USB cable and software CD for all "HT" and "HX" radios.



Art. 26005759

AT-15

BATTERY PACK

Li-Ion 7.2V 1200mAh rechargeable battery pack (original spare part) for "MT"/"DX" series.



Art. 25002310

LP-18

BATTERY PACK

High capacity Li-Poly 7.4V 1800mAh rechargeable battery pack for "MT"/"DX" series.



Art. 25002312

AT-68

BATTERY PACK

Li-Ion 7.4V 1200mAh rechargeable battery pack for "HT" and "HX" series (original spare part).



Art. 26005681

LN-865

BATTERY PACK

High capacity Li-Poly 7.4V 1800mAh rechargeable battery pack for "HT" and "HX" series.



Art. 26005682

NEW ! "XPS" SERIES

**7.4V 1700mAh
Li-POLY BATTERY !**
**DTMF CODING / PTT ID
VOICE ANNOUNCEMENT**
VHF 136-174 MHz FM 5W
UHF 420-470 MHz FM 4W
PMR446 16CH FM 0.5W

PROFESSIONAL HEAVY-DUTY HANDHELD TRANSCEIVER

Professional FM 16 channels handheld transceiver with diecast aluminum chassis, Heavy-Duty radio for business and professional use. PC programmable (with optional programming kit) and **data cloning** to other units (with optional cable). CTCSS, DCS, Time Out Timer, SCAN, Password protection, Selective Call (individual or group call), up to 5 programmable keys, Busy Channel Lockout. DTMF Coding and PTT ID. Waterproof earset-microphone M Type jack. Full set includes main unit, 7.4V Li-Poly 1700mAh battery pack and 230VAC desk type quick charger. Rubber flexible SMA antenna (fixed antenna in MT-446XPS).

Available versions :

MT-174XPS	VHF FM 5W	Art. 26005320
MT-460XPS	UHF FM 4W	Art. 26005322
MT-446XPS	PMR446 FM 0.5W	Art. 26005325

Main Features

- > 16 channels / 5W (VHF), 4W (UHF), 0.5W (PMR446) RF transmitter
- > Adjustable Hi-Low transmitter power on each channel
- > 38 CTCSS tones (Encoder/Decoder) / 83 DCS tones (Encoder/Decoder)
- > Time-Out-Timer / Low battery warning / DTMF Encoder / Lone Work
- > Dual narrow (12.5 KHz) / wide (25 KHz) selectable channel spacing (MT-174XPS / MT-460XPS)
- > Busy channel lockout / Talk Around function / Emergency Alarm
- > PC programmable functions : channel / frequency / TX RF output power / Squelch threshold level / CTCSS (Encoder/Decoder) and DCS (Encoder/Decoder) tone / SCAN / Time-Out-Timer / channel spacing

Full set includes main unit, SMA antenna, KB-70B 1700mAh battery pack and 230VAC desk type quick charger.

PC PROGRAMMABLE
"5T" SERIES
**DTMF
5-TONE / 2-TONE**
VHF 136-174 MHz FM 5W
UHF 420-470 MHz FM 4W

**PROFESSIONAL PC PROGRAMMABLE HANDHELD TRANSCEIVER
DTMF, 5-TONE, 2-TONE**

Professional FM 16 channels handheld transceiver with diecast aluminum chassis, suitable for business and professional use. Fully PC programmable professional transceiver (with optional programming kit), professional construction with **diecast aluminum chassis**. **VOX** function, simplex or semi-duplex operation. **CTCSS** and **DCS**, selectable frequency step. Busy Channel Lockout, Scrambler function. Three keys programmable for quick access functions. Selective calls **DTMF, 5-tone, 2-Tone**. Two language voice channel annunciator. **Emergency Alarm (4 types)** function. Full set includes main unit, 7.4V Li-Poly 1200mAh battery pack and 230VAC desk type quick charger. Rubber flexible SMA antenna.

Available versions :

MT-175N	VHF FM 5W	Art. 26005601
MT-465N	UHF FM 4W	Art. 26005603

Main Features

- > 16 channels (factory pre-programmed)
- > 5W (VHF), 4W (UHF) RF transmitter
- > 3 selectable channel bandwidth (12.5 / 20 / 25 KHz)
- > Emergency Alarm (4 types) / Scrambler function
- > VOX function / Time-Out-Timer / Busy Channel Lockout
- > 2 language voice channel annunciator
- > Selective Calls DTMF, 5-TONE, 2-TONE
- > PC programmable functions : channel / frequency / TX power / Squelch level / 38 CTCSS and 83 DCS tones encoder/decoder / VOX sensitivity / SCAN frequency step / TOT

Full set includes main unit, SMA antenna, KB-58B 1600mAh battery pack and 230VAC desk type quick charger.

PC PROGRAMMABLE
KME-315M
EARSET MIC

External earset-microphone with tie clip and PTT key, special soft cable, M type jack for "XPS" series.

Art. 26005340

KME-614M
EARSET MIC

External earset-microphone with tie clip and PTT key, rubber adjustable ear hanger, M type jack for "XPS" series.

Art. 26005341

KME-801M
EARSET MIC

External earset-microphone with PTT key, transparent earset, for security and bodyguard use, M type jack for "XPS" series.

Art. 26005342

KST-301M
SPEAKER MIC

External "Heavy Duty" speaker-mic with clip and PTT key, M type jack for "XPS" series.

Art. 26005343

CDXPS-1
PROGRAMMING KIT

PC interface cable and software CD for "XPS" series.

Art. 26005346

CDMT-5
PROGRAMMING KIT

PC interface cable and software CD for "5T" series.

Art. 26005633





**KME-315
EARSET MIC**

External earset-microphone with tie clip and PTT key, special soft cable, K type jack.

Art. 26005461



**KME-614
EARSET MIC**

External earset-microphone with tie clip and PTT key, rubber adjustable ear hanger, K type jack.

Art. 26005462



**KME-801
EARSET MIC**

External earset-microphone with tie clip, PTT key, transparent earset, for security and bodyguard use, K type jack.

Art. 26005463



**KME-100A
EARSET MIC**

External earset-microphone with tie clip and PTT key, K type jack.

Art. 26005458



**KME-200A
EARSET MIC**

External earset-mic with tie clip and PTT key, rubber adjustable extra-soft ear hanger, K type jack.

Art. 26005459



**KME-H115
SPEAKER MIC**

External speaker-microphone with adjustable clip and PTT key. TX LED, earphone jack, K type jack.

Art. 26005466



**KST-301
SPEAKER MIC**

External "Heavy Duty" speaker-mic with clip and PTT key, K type jack.

Art. 26005470



**KWT-001
CLONING CABLE**

Data cloning cable for "HT" and "HX" series.

Art. 26005475



**8560V
SMA ANTENNA**

VHF 136-174 MHz Rubber SMA antenna length 16cm.

Art. 26005430



**8560U
SMA ANTENNA**

UHF 400-470 MHz Rubber SMA antenna length 14.5cm.

Art. 26005432



**LCS-10
CARRYING CASE**

Soft leather carrying case with PVC transparent window for "DX" series, KT-380EE.

Art. 26005436



**LCS-20
CARRYING CASE**

Soft leather carrying case with PVC transparent window for "MT" series.

Art. 26005437

"MX-8000" SERIES

**SELECTIVE CALLS
DTMF 2-TONE**

VHF 136-174 MHz FM 25W

UHF 438-490 MHz FM 25W

5-25W FM



PROFESSIONAL PC PROGRAMMABLE MOBILE TRANSCEIVER

Professional FM mobile transceivers, very rugged construction with diecast aluminum chassis. 25W RF transmitter, 8 channels, 38 CTCSS and 83 DCS tones. Programmable by PC (with optional programming kit). LED Display, dual color RX/TX LED, **five user programmable keys, selective calls DTMF/2-Tone**, Scan, Emergency Alarm, Remote Kill, Public Address, Busy Channel Lockout, Time-Out-Timer, Password Protection, selectable Squelch level. Programmable RF output power range 5W to 25W. Compact cabinet, size mm150 x 53 x 130. Weight gr. 1030.

Available versions :

MX-8000V	VHF FM 25W	Art. 26005750
MX-8000U	UHF FM 25W	Art. 26005752

Main Features

- > 8 channels (factory pre-programmed)
- > 25W VHF/UHF RF transmitter
- > Adjustable TX power 25W-5W
- > Emergency Alarm / Lone Worker / Security Check
- > 38 CTCSS Tones / 83 DCS Tones (Encoder/Decoder)
- > Selective Calls DTMF/2-Tone
- > Busy Channel Lockout / TOT (Time-Out-Timer)
- > Public Address / Remote Kill / Password Protection
- > Adjustable Squelch level
- > 5 quick access function programmable keys
- > PC programmable functions : channel / frequency / TX power / Squelch level / 38 CTCSS and 83 DCS tones encoder/decoder / VOX sensitivity / SCAN frequency step / TOT



Large size heatsink provides heat dissipation for the high power Module RA30H4452M.

**CDMX-1-USB
PROGRAMMING KIT
WITH USB CABLE**



PC interface USB cable and software CD for "MX-8000" series.

Art. 26005756



MULTISTANDARD RADIO PMR446 / LPD433



MT-3030

**MULTISTANDARD
PMR446 / LPD433**

**PMR446 8CH / LPD433 69CH PAIR SET
DUAL STANDARD UHF FM
WALKIE-TALKIES**

Dual standard 77 channel (69CH LPD + 8CH PMR) handheld transceiver. Circuit complies with all CE/R&TTE regulations for both PMR446 and LPD433 bands. Backlighted LCD, SCAN, Dual Watch, VOX, Baby Monitor, CCTSS, Lock, Roger Beep, Call. Internal **squelch level adjustable** and **full 500mW ERP transmitter** (PMR band). Earset-microphone jack. Pair set includes radios, battery packs, earsets and AC chargers.

Art. 26005020

Main Features

- > PMR446 0.5W (10mW) ERP
- > LPD433 (10mW) ERP
- > 8CH PMR / 69CH LPD
- > Backlighted LCD with Battery status
- > RX/TX LED indicator
- > 38 CTCSS tones (Encoder/Decoder)
- > Auto Scan, Auto Squelch, Hi-Low TX power (PMR band), Dual Watch, VOX (Baby Monitor) with adjustable sensitivity, LOCK, 3 CALL ring tones, Keypad tone, Roger Beep tone, Monitor

Pair set includes 2 x radios, 800mAh battery packs, earsets-microphones and 230VAC chargers.



MT-4040

**MULTISTANDARD
PMR446 / LPD433**

2W (*) / 0.5W / 10mW

**PMR446 8CH / LPD433 69CH
DUAL STANDARD UHF FM 2-WAY RADIO**

Dual standard 77 channel (69CH LPD + 8CH PMR) handheld transceiver. Circuit complies with all CE/R&TTE regulations for both PMR446 and LPD433 bands. Backlighted LCD, SCAN, Dual Watch, VOX, Baby Monitor, CCTSS, Lock, Roger Beep, Call. Transmitter power 0.5W (PMR)/10mW (LPD). Earset-mic jack.

Art. 26005045

Main Features

- > PMR446 0.5W (10mW) ERP
- > LPD433 (10mW) ERP
- > 8CH PMR / 69CH LPD
- > Backlighted LCD display with Battery status indicator
- > RX/TX LED indicator
- > 38 CTCSS tones (Encoder/Decoder)
- > Scan, Auto Squelch, Hi-Low TX power (PMR band), Dual Watch, VOX (Baby Monitor) with adjustable sensitivity, Lock, 3 Call ring tones, Keypad tone, Roger Beep tone, Monitor



Package includes NMH-800 800mAh battery pack and 230VAC charger.

MT-4040EX (*)
International Version, features 2W ERP in both PMR446 and LPD433 bands. Not available for sale or use in the EEC countries.



**NMH-800
BATTERY PACK**

Ni-MH 4.8V 800mAh rechargeable battery pack (original spare part) for MT-3030 and MT-4040.

Art. 26005212



**DDC-800
DESK CHARGER**

Desk type automatic 230VAC 1-3 hours rapid charger for MT-4040.

Art. 26005257



**DDC-500
DESK CHARGER**

Desk type automatic 230VAC 1-3 hours rapid charger for MT-5050.

Art. 26005258

**See previous and following pages
for more optional accessories
for MT-3030 / MT-4040
MT-5050 / DRS-5070**



MT-5050

MULTISTANDARD
PMR446 / LPD433

4W (*) / 0.5W / 10mW

SCRAMBLER

OPTIONAL SMA ANTENNA

149 CHANNELS (*)

1500mAh Ni-MH BATTERY

**PMR446 8CH / LPD433 69CH
DUAL STANDARD UHF FM 2-WAY RADIO**

Handheld UHF FM 2-way radio for professional and business users. Multistandard circuit design, covering both the PMR446 and LPD433 bands, in compliance with the European CE/R&TTE regulations. According to the selected band (PMR or LPD), the CPU automatically controls the various specifications (channel spacing, deviation, selectivity, RF power, etc.) required for the PMR and LPD bands. **Scrambler. Adjustable digital Squelch threshold.** Backlighted LCD with S/RF Meter, SCAN, Dual Watch, VOX, Baby Monitor, CCTSS, Lock, Roger Beep, Call. High capacity **1500mAh Ni-MH battery** for over **40 hours battery life.** Earset-microphone jack.

Art. 26005070

Main Features

- > PMR446 0.5W (10mW) ERP / LPD433 (10mW) ERP
- > 8CH PMR / 69CH LPD
- > SCRAMBLER / 8 memory channels / RX/TX LED indicator
- > 38 CTCSS tones (Encoder/Decoder) / Battery level meter
- > SCAN, Memory SCAN, Auto Squelch, Hi-Low TX power (PMR band), Dual Watch, VOX (Baby Monitor) with adjustable sensitivity, Lock, 3 Call ring tones, Keypad tone, Roger Beep tone, Monitor, adjustable Squelch
- > Backlighted LCD with digital S/RF Meter

Package includes 1500mAh NI-MH batteries and 230VAC charger.



MT-5050EX (*) International Version, 4W ERP in both PMR446 and LPD433 bands. 30 PMR channels, 99 LPD channels, 20 PMR/LPD Semi-Duplex channels. Not available for sale or use in the EEC countries.

DRS-5070

MULTISTANDARD
PMR446 / LPD433

4W (*) / 0.5W / 10mW

SCRAMBLER

149 CHANNELS (*)

INTERNAL BATTERY OR 230VAC OPERATION

**PMR446 / LPD433 DESK TYPE
UHF FM 2-WAY RADIO**

PMR/LPD desk type station. **Scrambler. Adjustable Squelch threshold.** Adjustable Squelch level. Backlighted LCD, S/RF Meter, SCAN, Dual Watch, VOX, Baby Monitor, CCTSS, Lock, Roger Beep, Call. **230VAC power supply/charger included.** Radio may work on 230VAC power supply or on internal batteries. Earset-microphone jack. Fully compatible with model INTEK MT-5050.

Art. 26004900

Main Features

- > PMR446 0.5W (10mW) ERP / LPD433 (10mW) ERP / 8CH PMR / 69CH LPD
- > SCRAMBLER / 8 memory channels / RX/TX LED / Battery level meter
- > 38 CTCSS tones (Encoder/Decoder), SCAN, Memory SCAN, Squelch, Hi-Low TX power (PMR band), Dual Watch, VOX (Baby Monitor) with adjustable sensitivity, Lock, 3 Call ring tones, Keypad tone, Roger Beep, adjustable Squelch

230VAC switching type power supply/charger included.



DRS-5070EX (*) International Version, 4W ERP in both PMR446 and LPD433 bands. 30 PMR channels, 99 LPD channels, 20 PMR/LPD Semi-Duplex channels. Not available for sale or use in the EEC countries.



**MT-SM100
EARSET MIC**

Earset-microphone with adjustable tie clip and PTT key for MT-3030, MT-4040, MT-5050.

Art. 26005220



**MT-SM200
EARSET MIC**

Earset-mic with boom microphone, tie clip and PTT key, extra soft rubber ear hook.

Art. 26005230



**MT-SM200-N
EARSET MIC**

Same as model MT-SM200, but with 90° jack.

Art. 26005235



**SMA-505
SMA ADAPTOR**

Adaptor for SMA antenna for MT-5050.

Art. 26005262



**KA-505SR
RUBBER SMA
SHORT ANTENNA**

UHF 430-450 MHz Rubber SMA antenna length 20cm for MT-5050.

Art. 26005261



**KA-505LN
RUBBER SMA
LONG ANTENNA**

UHF 430-450 MHz Rubber SMA antenna length 39cm for MT-5050.

Art. 26005263



WALKIE-TALKIES

PMR446 AND LPD433
CONSUMER TYPE WALKIE-TALKIES

SL-02



MULTISTANDARD
PMR446 / LPD433

ULTRA-SLIM ! ONLY 14mm THICK

**PMR446 8CH / LPD433 69CH
DUAL STANDARD UHF FM
WALKIE-TALKIES PAIR SET**

Dual standard 77 channel (69CH LPD + 8CH PMR) pocket size handheld transceiver with **credit card size extra-slim 14mm case**. Circuit complies with CE/R&TTE regulations for both PMR446 and LPD433 bands. Backlighted LCD, SCAN, Dual Watch, VOX, Baby Monitor, CCTSS, Lock, Roger Beep, Call. Silent **vibration alert VIBRA-CALL**. Earset-microphone jack. Full pair set includes radios, battery packs, handlaces, earsets and switching type 230VAC chargers. Rubber touch soft finish cabinet.

Art. 26000202

Main Features

- > 8CH PMR / 69CH LPD
- > Backlighted LCD / Battery status indicator / RX/TX LED
- > 38 CTCSS tones / Silent vibration alert VIBRA-CALL
- > SCAN, Auto Squelch, Hi-Low TX power (PMR band), Dual Watch, VOX (Baby Monitor) with adjustable sensitivity, LOCK, 3 selectable CALL ring tones, Keypad tone, Roger Beep tone, Monitor, Last used channel memory
- > Dimension : mm 120 x 54 x 14
- > Weight : 76 gr. (battery included)



38 CTCSS TONES

SILENT VIBRATION ALERT

RUBBER TOUCH FINISH CABINET

CREDIT CARD SIZE !



Pair set includes 2 x radios, Li-Ion 720mAh battery packs, earsets-microphones, handlaces and 230VAC chargers.



**TH-1000
CARRYING CASE**

Soft carrying case with PVC window for SL-02.

Art. 26000300



**BLN-3720
BATTERY PACK**

Li-Ion 3.7V 720mAh rechargeable battery pack (original spare part) for SL-02.

Art. 26000260



**ESM-10
EARSET MIC**

Earset-microphone with tie clip and PTT key, for SL-02.

Art. 26000250

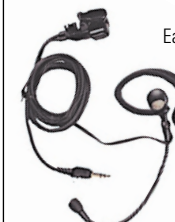

**ESM-20
EARSET MIC**

Earset-microphone with tie clip and PTT key, soft rubber adjustable ear hanger, for SL-02.

Art. 26000255



**SM-007-B1
EARSET MIC**

Earset-mic with tie clip and PTT key, transparent earset for safety and bodyguard, for SL-02.

Art. 26000240



i-Talk T30

PMR 446 MHz

0.5W / 10mW

LED TORCH



PMR446 8CH PAIR SET UHF FM WALKIE-TALKIES

PMR446 8CH pocket size walkie-talkie with integrated antenna and bi-color dark-brown/orange cabinet. LCD display indicates channel number, RX or TX mode and transmitter power level (high/low). Low battery alert tone, automatic channel SCAN, CALL and Power Save circuit to extend battery life.

Desk type double charger recharges two walkie-talkies at the same time. **Blue light LED torch** on top side of the radio. Full pair set includes 2 x radios, Ni-MH battery packs and 230VAC desk type double charger.

Art. 26006600



Pair set includes 2 x radios, Ni-MH 550mAh battery packs and 230VAC desk type double charger.

Main Features

- > 8 PMR446 channels
- > Transmitter power adjustable 500mW (high) or 10mW (low) ERP
- > LCD display / Battery alert indicator
- > Blue light LED torch
- > Automatic channel SCAN
- > CALL melody tone
- > Digital volume (8 levels)
- > Power save circuit
- > Desk type double charger included



i-Talk T40

PMR 446 MHz

0.5W / 10mW

LED TORCH



PMR446 8CH PAIR SET / UHF FM WALKIE-TALKIES

PMR446 8CH pocket size walkie-talkie with integrated antenna available in red-black color or in silver-black color. LCD display indicates channel number, RX or TX mode and transmitter power level (high/low). Low battery alert tone, automatic channel SCAN, CALL and Power Save circuit to extend battery life. **Blue light LED torch** on top side of the radio. Powered with 3 x AAA alkaline batteries (not included).

Art. 26006601

Main Features

- > 8 PMR446 channels
- > Transmitter power adjustable 500mW (high) / 10mW (low) ERP
- > LCD display / Battery indicator
- > Blue light LED torch
- > Channel SCAN
- > CALL melody tone
- > Digital volume (8 levels)
- > Power save circuit



BLN-3600 BATTERY PACK
Ni-MH 3.6V 550mAh rechargeable battery pack (original spare part) for i-Talk T30 and i-Talk T40.

Art. 26006605

i-Talk T90

PMR 446 MHz

0.5W / 10mW

STOP WATCH



PMR446 8CH PAIR SET UHF FM WALKIE-TALKIES

PMR446 8CH handheld walkie-talkie with **rubber touch finish case**. Full 500mW ERP transmitter (hi-low power control). Backlighted LCD display indicating channel and CTCSS number, battery level meter and every function enabled. 38 CTCSS private codes, VOX, Baby Monitor, CALL (5 melodies), LOCK, Channel and CTCSS SCAN, Dual Watch, keypad tone and **Roger Beep tone**. **Stop Watch**. Digital volume control (8 levels). Full pair set includes 2 x radios, Li-Ion battery packs, earset-microphones and 230VAC double charger.

Art. 26006615

Main Features

- > 8 PMR446 channels
- > Transmitter power 0.5W (10mW) ERP
- > 38 CTCSS private tones / Battery Level Meter
- > Stop Watch function / Backlighted LCD display
- > Auto Channel Scan, Auto CTCSS Scan, Auto Squelch, Hi-Low TX power, VOX (5 levels) and Baby Monitor, LOCK, Dual Watch, 5 Call ring tones, Roger Beep tone, digital volume (8 levels), keypad tone



Pair set includes 2 x radios, Li-Ion 720mAh battery packs, earsets-microphones and 230VAC desk type double charger.



43MHz RADIOS

43 MHz FM MOBILE AND HANDHELD COMMERCIAL TRANSCEIVERS

SY-5430M

43 MHz FM 4W/20W (*)



43 MHz 24CH 4W (20W) FM MOBILE TRANSCEIVER

43 MHz mobile transceiver with 24 channel FM 4W. Very **compact case (14 x 4 cm)** may be easily installed in every vehicle. Feature packed including SCAN, Dual Watch, Hi-Low transmitter power, LOCK, LCR, etc. Large size backlit LCD with digital S/RF meter and channel or **6-digit full frequency readout**. 5 memory channels and channel selection also on microphone.

Art. 24005430

Main Features

- > 24 channel FM 4W (CE version)
- > Backlit LCD Display with channel and 6-digit frequency readout
- > Scan, Dual Watch, EMG, LCR (Last Used Channel Recall), CH13
- > Digital S/RF Meter
- > Condenser Microphone with UP/DOWN channel keys
- > Quick UP/Quick DOWN channel selection
- > 5 memory channels and automatic memory channel scan

SY-5430M-EX (*)

International Version, 20W ERP and 224 channels. Not available for sale or use in the EEC countries.

SY-343/SY-90

43 MHz FM 4W

43 MHz 24CH 4W FM HANDHELD TRANSCEIVER

43 MHz FM **4W** handheld transceiver with 24 channel. SCAN, Dual Watch, Hi-Low transmitter power, LOCK, LCR, etc. Backlit LCD with digital S/RF meter, external earset-microphone jack and **compatible with mobile car adaptor** model CAR-101. Set comes with 230VAC charger and rechargeable battery case for 9 x AA Ni-MH 1.2V (batteries not included). This transceiver is fully compatible with the mobile version model SY-5430M. 2-pin standard ear-mic jack.

Art. 24000346

Main Features

- > FM 4W / 24CH (CE version)
- > Backlit LCD Display with Digital S/RF Meter
- > Scan, Dual Watch, EMG CH13
- > LCR (Last Used Channel Recall)
- > Hi-Low transmitter power selectable
- > External earset-microphone jack
- > Compatible with mobile car adaptor CAR-101
- > 10.8V battery case may contain 9 x AA Ni-MH batteries (batteries not included)



Package includes radio, antenna, strap, Ni-MH empty battery case 10.8V and 230VAC charger.

AC-101

230V ADAPTOR

230VAC adaptor charger for SY-343/SY-90.



Art. 36005810

BP-106

9V BATTERY PACK

9V battery pack contains 6 x AA alkaline batteries (not included) for SY-343/SY-90.



Art. 36005814

SY-90

10.8V BATTERY PACK

10.8V rechargeable battery pack contains 9 x AA Ni-MH batteries (not included) for SY-343/SY-90.



Art. 36005820

CAR-101

MOBILE CAR ADAPTOR

Converts SY-343 into a mobile transceiver, power supply is taken directly from the vehicle electric system, cigarette lighter adaptor socket. SO-239 RF antenna connector.



Art. 36005808



MARINE RADIO

MARINE VHF HANDHELD TRANSCEIVERS



DOLPHIN

5W / 1W

50 PRIVATE CHANNELS (*)

SCRAMBLER (*)

38 CTCSS TONES (*)

VHF FM MARINE TRANSCEIVER WITH ADVANCED FUNCTIONS

VHF FM marine (156-162 MHz) handheld radio with splash proof cabinet. **Backlighted LCD**, digital **S/R/F meter**, channel, CTCSS tone number and all enabled functions are indicated by the LCD. All US, Canada, International and Weather channels. **Transmitter power adjustable (5W/1W)**. SCAN, Dual Watch, CH16, 8 memory channels, LOCK. Battery level meter. Adjustable squelch (6 levels), **VOX** for handsfree operation. Package includes 1500mAh Ni-MH batteries and travel charger.

Art. 27001000

Main Features

- > All US, Canada, Int. and Weather channels
- > Backlighted LCD display
- > Adjustable RF output power 5W/1W
- > S/R/F Meter and 4-bar Battery level Meter
- > LOCK, CH16, SCAN, Dual Watch, BUSY
- > VOX handsfree operation (4 level sensitivity)
- > 8 memory channels
- > 2-pin standard ear-mic jack

1500mAh Ni-MH BATTERY



DOLPHIN-EX (*)

International Version, with 38 CTCSS Tones, 50 private channels and Scrambler function. Not available for sale or use in the EEC countries.

Package includes 1500mAh NI-MH batteries and 230VAC charger.



seatec-5

100 MEMORIES

5W / 2W / 1W

1.8" 4-LINES LCD

120 PRIVATE CHANNELS
PC PROGRAMMABLE

VHF FM MARINE TRANSCEIVER WITH ADVANCED FUNCTIONS

VHF FM marine (156-162 MHz) handheld radio **PC programmable** (with optional programming kit). Backlighted wide **4-lines 1.8" LCD**, digital **S/R/F meter**, channel and **6-digit frequency readout**. All enabled functions are indicated by the LCD. All US, Canada, International and Weather channels, **100 memory channels** and **120 private channels programmable**. Transmitter power adjustable (3 levels). Manual or auto squelch. SCAN, Dual Watch, Triple Watch, CH16, priority channels, key lock, ATIS/alert. Battery level meter. Full set includes 1500mAh Ni-MH batteries and travel charger.

Art. 27002000

Main Features

- > All US, Canada, Int. and Weather channels
- > 4-lines 1.8" extra-wide backlighted LCD display with channel and 6-digit full frequency readout
- > Adjustable RF output power 5W/2W/1W
- > S/R/F Meter and 4-bar Battery level Meter
- > LOCK, CH16, SCAN, Dual Watch, Triple Watch, Priority, ATIS/alert
- > 120 private channels (frequencies) programmable
- > 100 memory channels
- > Manual or Auto Squelch
- > 2-pin standard ear-mic jack



Package includes 1500mAh Ni-MH batteries and 230V charger.



DDC-500

DESK CHARGER

Desk type automatic 230VAC 1-3 hours rapid charger for MT-5050.

Art. 26005258



MT-SM100

EARSET MIC

External earset-microphone with tie clip and PTT key, S type jack for DOLPHIN.

Art. 26005220



MT-SM200

EARSET MIC

External earset-mic with tie clip and PTT key, rubber adjustable ear hanger, S type jack, for DOLPHIN.

Art. 26005230



CDMR-8050

PC SOFTWARE

PC interface cable and software CD for seatec-5.

Art. 27002005



ACCESSORIES

**EARSETS, MICROPHONES, HEADSETS,
SPEAKERS, BATTERY PACKS, ANTENNAS**

DMC-507 **DYNAMIC**
DMC-507/4P



DYNAMIC CB MICROPHONE
Quality dynamic microphone for CB transceivers, impedance 500 Ohm, with or without 4-pin connector.

Without 4-pin connector Art. 35000100
With 4-pin connector Art. 35000101

DMC-507N/4P **DYNAMIC**



DYNAMIC CB MICROPHONE
Quality dynamic microphone for CB transceivers, impedance 500 Ohm, with 4-pin connector. Metal rear hanger and extra soft microphone cable.

Art. 35000208

DMC-550/4P **DYNAMIC**



DYNAMIC CB MICROPHONE
Quality dynamic microphone for CB transceivers, impedance 500 Ohm, with 4-pin connector. Extra soft microphone cable.

Art. 35000200

DMC-401/4P **DYNAMIC**



DYNAMIC CB MICROPHONE
Quality dynamic microphone for CB transceivers, impedance 500 Ohm, with 4-pin connector. Heavy duty cabinet and PTT switch.

Art. 35000211

DMC-402/4P **DYNAMIC**



DYNAMIC CB MICROPHONE
Quality dynamic microphone for CB transceivers, imp. 500 Ohm, 4-pin connector. Heavy duty cabinet and PTT switch, metal hanger and cable steel protection coil.

Art. 35000212

MC-S10 **ELECTRET**



ELECTRET CB MICROPHONE
Quality electret microphone for CB transceivers, with 4-pin connector (original spare part for M-60/100/120/130/150 PLUS and M-899 VOX).

Art. 80002220

MC-S50 **ELECTRET**



ELECTRET CB MICROPHONE
Quality electret microphone for CB transceivers, with 6-pin connector, UP/DN/LOCK keys, (original spare part for M-550 POWER).

Art. 80002211

MC-S60 **ELECTRET**



ELECTRET CB MICROPHONE
Quality electret microphone for CB transceivers, with 6-pin connector, UP/DN/LOCK keys, (original spare part for M-760 PLUS).

Art. 80002212

MC-S79 **DYNAMIC**



DYNAMIC CB MICROPHONE
Quality dynamic microphone for CB transceivers, with 6-pin connector, UP/DN/LOCK keys, (original spare part for M-799 PLUS).

Art. 80002213

MC-S90 **DYNAMIC**



DYNAMIC CB MICROPHONE
Quality dynamic microphone for CB transceivers, with 6-pin connector, UP/DN/LOCK keys, (original spare part for M-490 PLUS, M-495/795 POWER).

Art. 80002210



EARSET-MICROPHONES / SPEAKER-MICROPHONES WITH 2-PIN S-TYPE CONNECTOR

<p>MT-SM100</p>  <p>EARSET MICROPHONE Earset-microphone with adjustable tie clip and PTT key.</p> <p>Art. 26005220</p>	<p>MT-SM200</p>  <p>EARSET MICROPHONE Earset-mic with flexible boom microphone, adjustable tie clip and PTT key, extra-soft rubber ear hook.</p> <p>Art. 26005230</p>	<p>MT-SM200-N New !</p>  <p>EARSET MICROPHONE Earset-microphone with flexible boom, adjustable tie clip and PTT key, 90° jack for MT-5050 and similar.</p> <p>Art. 26005235</p>	<p>SM-007-A1</p>  <p>EARSET MICROPHONE Earset-microphone with tie clip and PTT key, transparent earset for security and bodyguard use.</p> <p>Art. 35003070</p>
<p>EM-6S</p>  <p>EARSET MICROPHONE Earset-microphone with adjustable tie clip and PTT key.</p> <p>Art. 35003006</p>	<p>EM-7S</p>  <p>EARSET MICROPHONE Earset-microphone with adjustable tie clip and PTT key, extra-soft rubber ear hook.</p> <p>Art. 35003007</p>	<p>EM-8UNI</p>  <p>EARSET MICROPHONE Earset-microphone with tie clip and PTT key, earset with flexible boom.</p> <p>Art. 35003058</p>	<p>EM-9S</p>  <p>EARSET MICROPHONE Earset-microphone with tie clip and PTT key, adjustable left or right ear hook.</p> <p>Art. 35003009</p>
<p>EM-10S</p>  <p>EARSET MICROPHONE Earset-microphone with adjustable tie clip and PTT key, adjustable left or right side earset with flexible boom microphone.</p> <p>Art. 35003010</p>	<p>KT-SM3</p> <p>SPEAKER MICROPHONE Speaker-microphone with clip and PTT key, compact size.</p>  <p>Art. 35005015</p> <p>S TYPE CONNECTOR INTEK - ICOM - YAESU</p>  <p>Two-Pin Straight 3.5mm Mono + 2.5mm Mono</p> <p>Compatible with : H-510 PLUS / H-512 PLUS / H-520 PLUS MT-3030 / MT-4040 / MT-5050 DRS-5070 / seatec-5 / DOLPHIN SY-343/SY-90</p>		

TA-9526 CHATTER BOX

MOTORCYCLE INTERCOM



MOTORCYCLE INTERCOM
BI-DIRECTIONAL COMMUNICATION DRIVER-PASSENGER

Motorcycle intercom set allows bi-directional voice communication between driver and passenger. Compact size main unit with belt clip, adjustable volume and two earset-microphone sets with soft curl cord and jack for fast connection to the main unit. Powered by 4 alkaline AAA batteries. Power ON LED. Low cost and simple to use set suitable for both integral helmets and jet helmets.

Art. 77005000



**CB-5****5W****EXTERNAL SPEAKER**

External speaker for mobile transceivers, compact size, adjustable mounting bracket and 2 meters cable with standard jack. Impedance 8 ohm, power 5W.

Art. 3600205

FSP-10**5W****EXTERNAL SPEAKER**

External speaker for mobile transceivers, compact size, 2 mounting brackets, one for car and one for truck sunshade fin mounting. 4 meters cable with standard jack. Impedance 8 ohm, power 5W.

Art. 36002010

FSP-20**5W****EXTERNAL SPEAKER**

External speaker for mobile transceivers, adjustable mounting bracket and 2 meters cable with standard jack. Impedance 8 ohm, power 5W.

Art. 36002020

FSP-30**12W****EXTERNAL SPEAKER**

External speaker for mobile transceivers, specially suitable for trucks, adjustable mounting bracket and 3 meters cable with standard jack. Impedance 8 ohm, power 12W.

Art. 36002030

FSP-50**8W****EXTERNAL HORN DIRECTIONAL SPEAKER**

External horn directional speaker for mobile transceivers, adjustable mounting bracket and 3 meters cable with standard jack. Impedance 8 ohm, power 8W.

Art. 36002050

MR-1500AA**SELECTED CELLS****RECHARGEABLE Ni-MH
1.2V 1500mAh AA BATTERIES**

ORIGINAL INTEK RECHARGEABLE BATTERIES
HIGH QUALITY SELECTED CELLS
SUITABLE FOR USE WITH HANDHELD
TRANSCIEVERS

**MR1500AA 1.2V / 1500mAh** Art. 36009910**MY-579B****NYLON****SOFT CARRYING CASE**

Soft Nylon carrying case, with elasticized sides to insert radios of different size. Elasticized upper tab with velcro fixing. Adjustable belt fixed on three points.

Art. 36001400

MY-579L**NATURAL LEATHER****SOFT CARRYING CASE**

Soft Leather carrying case, with elasticized sides to insert radios of different size. Elasticized upper tab with velcro fixing. Adjustable belt fixed on three points.

Art. 36001410



MAG-1345

26-28 MHz

35 CM

30W PEP



CB CAR MAGNET ANTENNA

27 MHz (26-28 MHz) CB mobile antenna with magnet base and 4m RG-58/U cable and PL-259 connector. Steel whip with protective rubber cup. Locking screw for adjusting and tightening the antenna whip. Base diameter 7 cm. Length 35 cm, gain 3 dB, weight 400 gr.

Art. 41001250

MAG-1349

26-30 MHz

95 CM

300W PEP

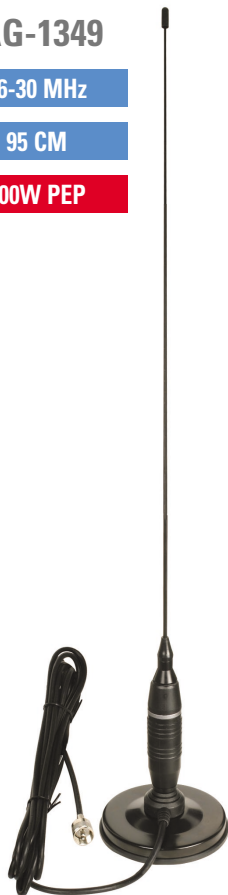

CB CAR MAGNET ANTENNA

27 MHz (26-30 MHz) CB mobile antenna with magnet base and 4.8m RG-58/U cable and PL-259 connector. Steel whip with protective rubber cup. Locking screw for adjusting and tightening the antenna whip. Base diameter 10 cm. Length 95cm, gain 3 dB, weight 720 gr.

Art. 41001255

TUNABLE VHF/UHF SMA RUBBER ANTENNAS

VHF

UHF

UHF SHORT



INTEK EA-144C SMA
144-175 MHz

Art. 40006010



INTEK EA-400L/C SMA
400-520 MHz

Art. 40006018



INTEK EA-400S/C SMA
400-520 MHz

Art. 40006015

These new rubber antennas can be conveniently tuned to the exact specific required frequency, by simply removing the rubber cup and cutting the antenna into the proper length, as per the enclosed frequency-length chart. Once the antenna has been cut, the rubber cup may be re-installed on top of the antenna and fixed with one drop of glue. Antennas are available for VHF/UHF/PMR frequencies.

INTEK EA-400S/C SMA

Freq.	Length
400MHz	101mm
410MHz	91mm
420MHz	90mm
430MHz	89mm
440MHz	88mm
450MHz	86.5mm
460MHz	84.5mm
470MHz	81.5mm
480MHz	80mm
490MHz	77.5mm
500MHz	76.5mm
510MHz	75.5mm
520MHz	75mm



KA-520

27 MHz



27 MHz ANTENNA

27 MHz CB rubber antenna with BNC connector, original spare part for INTEK H-510 PLUS, INTEK H-512 PLUS, INTEK H-520 PLUS CB handheld transceivers.

Art. 05005005

KA-702C

VHF
UHF



VHF / UHF ANTENNA

Dual-band VHF/UHF
140-150 MHz / 430-450 MHz rubber flexible antenna, length cm 22, gain 2.15/3.00 dB, RF max. 10W, BNC connector.

Art. 41001110

KA-410T

VHF
UHF



VHF / UHF ANTENNA

Dual-band VHF/UHF
140-150 MHz / 430-450 MHz telescopic antenna, length cm 41.5, gain 3.5 dB, RF max. 10W, BNC connector.

Art. 41001115

KA-930T

VHF
UHF



VHF / UHF ANTENNA

Dual-band VHF/UHF
140-150 MHz / 430-450 MHz telescopic antenna, length cm 94, gain 3.5/6.0 dB, RF max. 50W, BNC connector.

Art. 41001125



SPS-8040

13.8V 3A



SWITCHING TYPE REGULATED 13.8V 3A POWER SUPPLY

Switching type regulated power supply, much more efficient compared to ordinary linear power supplies. A light and compact size package delivers a high output current. Suitable to provide regulated DC power supply to CB, VHF/UHF mobile transceivers. 230VAC 50Hz input and regulated 13.8VDC output with 3A maximum current. **Automatic electronic protection against over-loading and short circuits.** Size mm 90 x 55 x 135. Weight 500 gr.

Art. 30002040

SPS-8041

3-12V 3A



SWITCHING TYPE REGULATED 3-4.5-6-7.5-9-12V 3A POWER SUPPLY

Switching type regulated power supply, much more efficient compared to ordinary linear power supplies. A light and compact size package delivers a high output current. Suitable to provide regulated DC power supply to CB, VHF/UHF mobile transceivers. 230VAC 50Hz input and regulated selectable DC output voltage (3-4.5-6-7.5-9-12V) with 3A maximum current. **Automatic electronic protection against over-loading and short circuits.** Size mm 90 x 55 x 135. Weight 500 gr.

Art. 30002041

SPA-8100

13.8V 10A



SWITCHING TYPE REGULATED 13.8V 10A POWER SUPPLY

Switching type power supply, with regulated fixed DC output voltage. High stability and protection against radio frequency, suitable to provide regulated DC power supply to CB, VHF/UHF mobile transceivers. 230VAC 50Hz input and regulated 13.8VDC output with 10A maximum current. Internal DC output voltage fine adjustment (13.3-14.5VDC). **Automatic electronic protection against over-loading, over-temperature and short circuits.** Standard terminals and lighter socket. Size mm 181 x 63 x 190. Weight 1.5 kg.

Art. 30002060

SPA-8230

13.8V 23A



SWITCHING TYPE REGULATED 13.8V 23A POWER SUPPLY

Switching type power supply, with regulated fixed DC output voltage. High stability and protection against radio frequency, suitable to provide regulated DC power supply to CB, VHF/UHF mobile transceivers. 230VAC 50Hz input and regulated 13.8VDC output with 23A maximum current. Internal DC output voltage fine adjustment (13.3-14.5VDC). **Automatic electronic protection against over-loading, over-temperature and short circuits.** Standard terminals and lighter socket. Cooling fan with automatic variable speed. Size mm 181 x 63 x 190. Weight 1.7 kg.

Art. 30002065

POWER SUPPLIES
DC REGULATED POWER SUPPLIES
DC/DC 24/12V CONVERTERS



SPS-8250

3-15V 25A



SWITCHING TYPE REGULATED 3-15V 25A POWER SUPPLY

Professional switching type power supply. Selectable adjustable DC output voltage 3-15V or fixed DC output voltage 13.8V. Maximum output current 25A. High stability and **protection against radio frequency**, suitable to provide regulated DC power supply to CB, VHF/UHF mobile transceivers. 230VAC 50Hz input. **Automatic electronic protection against over-loading, over-temperature and short circuits**. Wide analogic voltage and current meters. Size mm 220 x 110 x 225. Weight 3 kg.

Art. 30007000

SPS-8400

3-15V 40A



SWITCHING TYPE REGULATED 3-15V 40A POWER SUPPLY

Professional switching type power supply. Selectable adjustable DC output voltage 3-15V or fixed DC output voltage 13.8V. Maximum output current 40A. High stability and **protection against radio frequency**, suitable to provide regulated DC power supply to CB, HF, VHF/UHF mobile and base transceivers. 230VAC 50Hz input. **Automatic electronic protection against over-loading, over-temperature and short circuits**. Wide analogic voltage and current meters. Size mm 220 x 110 x 300. Weight 3.5 kg.

Art. 30007005

SPS-9400

3-15V 40A



SWITCHING TYPE REGULATED 3-15V 40A POWER SUPPLY

Professional switching type power supply. Selectable adjustable DC output voltage 3-15V or fixed DC output voltage 13.8V. Maximum output current 40A. High stability and **protection against radio frequency**, suitable to provide regulated DC power supply to CB, HF, VHF/UHF mobile and base transceivers. 230VAC 50Hz input. **Automatic electronic protection against over-loading, over-temperature and short circuits**. Digital voltage and current meters. Size mm 220 x 110 x 300. Weight 3.5 kg.

Art. 30007010

RD-10A

10A MAX



24-12V 10A DC-DC VOLTAGE CONVERTER

DC-DC voltage converter, input 24VDC, output 12VDC, maximum peak current 10A. Suitable for use with CB, VHF/UHF mobile transceivers. **Built-in automatic electronic protection against over-voltage, over-current and input polarity reverse**. Size mm 100 x 122 x 60. Weight 700 gr.

Art. 30008010

RD-20A

18A MAX



24-12V 18A DC-DC VOLTAGE CONVERTER

DC-DC voltage converter, input 24VDC, output 12VDC, maximum peak current 18A. Suitable for use with CB, VHF/UHF mobile transceivers. **Built-in automatic electronic protection against over-voltage, over-current and input polarity reverse**. Size mm 200 x 130 x 66. Weight 1.25 kg.

Art. 30008020

RDS-12A

12A MAX



24-12V 12A SWITCHING TYPE DC-DC VOLTAGE CONVERTER

DC-DC switching type voltage converter, wide voltage input range 18-30VDC, output 12.8VDC, maximum peak current 12A. Suitable for use with CB, VHF/UHF mobile transceivers. **Built-in automatic electronic protection against over-load and input polarity reverse**. Size mm 168 x 105 x 55. Weight 800 gr.

Art. 30008050



PAGING SYSTEMS ALARMS, SAFETY

VOICE PAGERS, REMOTE ALARMS
AND SAFETY PRODUCTS



FULLY OPERATOR PROGRAMMABLE

RUBBER TOUCH FINISH CABINETS



RP-801R voice Pager comes with earset, necklace and belt clip (batteries not included)

RP-801T Transmitter comes with necklace and belt clip (microphone and batteries not included)

DESIGNED FOR TOURISTS GUIDED TOURS, MUSEUMS OR OUTDOOR TOURS, CONFERENCES AND TRANSLATIONS, MOTORCYCLE DRIVING SCHOOLS, OFFICES, STORES, WAREHOUSES, HOTELS, RESORTS, RESTAURANTS, HOSPITALS, FACTORIES, SAFETY, SECURITY PURPOSES, ETC.

RP-800

860 MHz 79 CHANNELS UHF FM

USER FRIENDLY OPERATION

860 MHz UHF FM PROFESSIONAL PAGING SYSTEM DESIGNED FOR TOUR OPERATORS, TOURISTS GUIDED TOURS, CONFERENCES, ETC.

Compact and light weight UHF FM voice pager and transmitter. **User friendly designed** for tour operators and tourists guided tours, it is also suitable for conferences, translations, etc. System operates on the 860 MHz UHF FM band, which is usually free from interferences. Voice pager and transmitter are **programmable by the operator. Two operating modes (USER mode and PROGRAMMING mode)** are available. When pager is set in USER mode, user can only operate the On/Off and the Volume controls, every other function is disabled, in order to prevent user from entering wrong commands. Removable battery case, built-in antenna, **rubber touch finish cabinets**, choice of convenient necklace or belt clip. Backlighted LCD display shows all functions in the Program Mode and only volume and battery levels in the User Mode. **79 channels** selectable. 3 x AA battery powered. Battery charging with desk type multiple chargers. Complete with necklace, belt clip and earset.

RP-800R PAGER Art. 70000400

RP-800T TRANSMITTER Art. 70000450

Main Features

General

Frequency 863.025 - 864.975 MHz / 79 Channels / Mode NFM
Backlighted LCD with Battery indicator
3.6V (3 x AA 1.2V Ni-MH batt.) or 4.5V (3 x AA 1.5V alkaline batt.)
Dimensions mm 62 x 120 x 21 / Weight gr. 150

Voice Pager (RP-800R)

Earset jack / 10 hours battery life (continuous receive)
Auto squelch (3 levels)

Transmitter (RP-800T)

Microphone jack / 10 hours battery life (continuous transmit)
PTT or VOX (handsfree) operation / HI-LO transmitter power



EA-801A EARSET

Earset with 60cm cable (one earset is included with every RP-800R pager).

Art. 70000420



EM-801A MICROPHONE

Microphone with tie clip and 60cm cable, for RP-800T transmitter.

Art. 70000460



EM-805A MICROPHONE

Microphone w/adjustable boom and neck support, for RP-800T transmitter.

Art. 70000465

MDC-800EU DESK TYPE QUICK CHARGER

Recharges simultaneously up to 50 units pagers or transmitters. About 5 hours charge time. CPU controlled charging for each single position, LED indicators. Power 230VAC. Dimensions mm 450x490x105. Weight kg. 7.5



Art. 70000440



RP-600

UHF FM PMR 446 - LPD 433 DUAL BAND VOICE PAGER

8 PMR + 69 LPD CHANNELS 52 PRIVATE CHANNELS 38 CTCSS TONES

**UHF FM PMR 446 MHz / LPD 433 MHz DUAL-BAND VOICE PAGER
DESIGNED FOR TOUR OPERATORS, TOURISTS GUIDED TOURS, CONFERENCES, ETC.**

Compact and light weight UHF FM voice pager. **It can be used with any PMR or LPD transmitter.** User friendly design, suitable for conferences, meetings or for security purposes, motorcycle driving schools, restaurants, hotels, resorts, hospitals, offices, stores, warehouses, etc. Necklace or belt clip. Listen from the supplied earset or from the **built-in speaker**. Pager is **operator programmable** (channel, CTCSS tone, voice only, voice or vibration alert, etc.). In the **USER Mode**, user can only operate the ON/OFF key and the volume controls, in order not to enter wrong commands. Backlighted LCD display shows all functions in the **PROGRAM Mode** while only the volume and battery levels are displayed in User Mode. 129 channels selectable. Complete with necklace, belt clip and earset.

Main Features

- > 8 PMR446 channels / 69 LPD433 channels / 52 private LPD/PMR channels
- > 38 CTCSS tones / Backlighted LCD Display / Busy icon / Battery level
- > Vibration Alert (if used with DRS-5070 or SL-02 transmitter)
- > USER Mode and PROGRAM Mode (Operator programmable)
- > 2 receiving modes (Voice only, Voice + Vibration)
- > External Earset Jack / Wall Charger Jack
- > Dimensions : L60 X D36 x H85 mm / Weight : gr. 80
- > Power Source : 2 x 1.2V AA Ni-MH or 2 x 1.5V AA alkaline batteries

Art. 70000200



Each Pager comes with earset, necklace and belt clip

USER FRIENDLY OPERATION

SILENT VIBRATION ALERT

RUBBER TOUCH FINISH CABINET

EARSET OR BUILT-IN SPEAKER OPERATION



**MT-5050 PMR446 / LPD433
PORTABLE TRANSMITTER**

PMR446 / LPD433 handheld transmitter, **compatible with the RP-600 voice pager**. Radio is complete with high capacity 1500mAh Ni-MH batteries for over 40 hours battery life and with a 230VAC wall charger. Optional desk type rapid charger (DDC-500). Various types of external microphones are available.

See page 19 for full details



**DRS-5070 PMR446 / LPD433
DESK TYPE TRANSMITTER**

PMR446 / LPD433 desk type transmitter, **compatible with the RP-600 voice pager**. Radio is complete with 230VAC power supply/charger. Internal battery operation is also possible. Suitable for desk type operation, such as conferences, translations, offices, etc.

See page 19 for full details

Suggested portable and desk type transmitters for RP-600 Pagers



**EA-601A
EARSET**

Earset with soft silicon hear hanger and 60cm cable (one earset is included as a standard part with every RP-600 pager).

Art. 70000300



**AC-600EU
WALL CHARGER**

230VAC wall charger, for RP-600 pager. Charging time approx. 12-14 hours.

Art. 70000205

**MDC-600EU
DESK TYPE QUICK CHARGER**

Recharges simultaneously up to 50 pagers. About 5 hours charge time. CPU controlled charging process for each single position, LED indicators. Power 230VAC. Dimensions mm 450x490x105. Weight kg. 7.5

Art. 70000220





AP-601

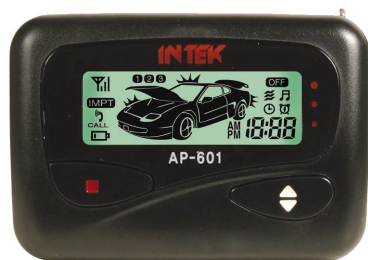

UHF FM REMOTE ALARM SYSTEM

65.000 DIGITAL CODES

2 KM RANGE



DIGITAL CODED UHF FM REMOTE ALARM WITH LCD POCKET PAGER FOR VEHICLES, MOTORCYCLES, BOATS, HOUSES, CAR BOXES, BUILDINGS, ETC.

This set includes a remote pocket pager, that can immediately receive an alarm message from the UHF transmitter unit installed in a vehicle or building. The system may also be used by old persons to recall attention as well as for various other safety applications. The pocket pager has a **wide LCD display** showing the details of the received alarm (example door car opened). The UHF FM transmitter has a **digital coding system with 65.000 codes**, to prevent interferences or faulty alarms. Set includes a **vibration/movement sensor**, with adjustable sensitivity and a small size transmitting antenna. Pager notifies incoming alarm with an **audio tone o with a silent vibration alert** and the LCD display indicates the type of alarm (doors open/closed, trunk open/closed, engine door open/closed, crash, engine started). It also indicates if you are within the transmitter range, time, type of selected alarm and battery level. Pager is powered with one AAA alkaline battery. Various applications of this system also include **wireless remote control of buildings, houses, offices, warehouses, car boxes, etc.** with immediate transmission of an alarm up to a **distance of approx. 2km**, without any wiring or cables.

Art. 70000100

Main Features

- > Frequency range 433.075-434.775 MHz UHF FM
- > 1 channel (spacing >25 KHz)
- > 65.000 digital codes
- > Transmitter power 10mW ERP
- > Transmitter Size mm 91 x 70 x 30 / Weight 100 gr.
- > Transmitter DC input voltage 12.0VDC
- > Receiver power source 1.5V (1 x AAA battery)
- > Receiver Size mm 63 x 44 x 18 / Weight 60 gr.



Set includes transmitter, receiver, vibration/movement sensor, rubber TX antenna, receiver cover, handstrap, AAA alkaline battery.

SUITABLE FOR VARIOUS APPLICATIONS



RM-446

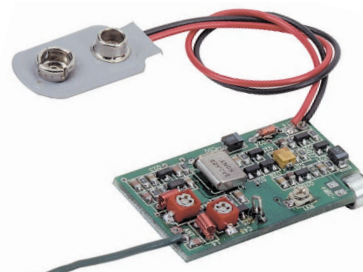

433-446 MHz

VOX

Art. 38000446

UHF FM (433-446 MHz) ROOM MICRO-TRANSMITTER WITH VOX (*)

UHF FM micro-transmitter, 433-446 MHz. High microphone sensitivity (adjustable) and **VOX function** for automatic transmission when sound is detected by the microphone. VOX can be disabled for continuous transmission. Approx. **3 months operating time** (in VOX mode), with one 9V battery. **Size mm 42 x 23 x 5 mm thick**. Power 6-14V only 12-13mA. Max range **500 meters**.

TT-140

Art. 38000140

140-150 MHz

VHF FM (140-150 MHz) TELEPHONE MICRO-TRANSMITTER (*)

VHF FM telephone micro-transmitter, 140-150 MHz. To be installed in series with telephone line. Range of max **500 meters**. **Unlimited operating time**, powered is taken directly from the telephone line. **Size mm 24 x 22 x 5 mm thick**.

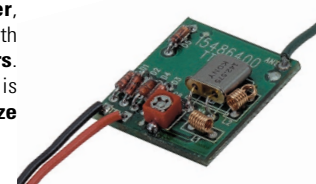

(*) Product not CE approved, for use by police or other authorized corps. Sales and operation of this device are restricted. Please check details with your local dealer.

CCD-SC1

DUMMY CCTV CAMERA

DUMMY SURVEILLANCE CAMERA

Identical to a true CCTV camera, with **working red LED** indicator, lasts about **six months with 2 pcs A batteries**. Convenient method for crime dissuasion. Comes with bracket, hardware and a **WARNING ! label**, showing that the area is subject to video surveillance.



WARNING !
AREA PROTECTED BY
VIDEO SURVEILLANCE
WITH RECORDING

**A SMART AND LOW COST
ANTI-CRIME SOLUTION !**

Art. 70000500



RECEIVERS
SHORTWAVE WIDE BAND
AND SCANNING RADIOS



AR-109

VHF AM AIR / VHF NFM / VHF WFM

LISTEN TO COMMERCIAL, BUSINESS
AND SPORT AIRPLANES AND
AIRPORT RADIO COMMUNICATION

99 MEMORY CHANNELS

**VHF AM AIR BAND SCANNER 108-137 MHz
(137-174 MHz NFM / 88-108 MHz WFM FM)**

Pocket size air band scanner. Back lighted LCD display. Rubber touch compact case, 26 mm width. Designed to monitor the air band radio communication traffic, covers the **VHF AM air band, with frequency steps at 8.333 KHz or 25 KHz**, the VHF NFM band (137-180 MHz) and the FM radio band (88-108 MHz WFM). **99 memory channels**, Scan, Dual Watch, selectable frequency steps in the air band (8.333 KHz or 25 KHz), in the VHF NFM band (5-10-12.5-15-20-25-50 KHz), in the VHF WFM band (100 KHz). Complete with **2 x AA Ni-MH batteries and 230VAC charger**. External earset jack.

Art. 50000109

Main Features

- > VHF AM Air band (108.000-136.975 MHz)
- > VHF NFM band (137-180 MHz)
- > FM radio band (88-108 MHz WFM)
- > Air Band freq. steps 8.333 / 25 KHz
- > VHF NFM band freq. steps 5-10-12.5-15-20-25-50 KHz
- > Backlighted LCD display with 7-digit full frequency indication
- > Battery level Meter / digital S-Meter
- > Power Save, Key Lock, Keypad beep tone
- > Busy, Monitor, Skip, Delay
- > 99 programmable memory channels



Set includes 2 AA rechargeable Ni-MH batteries
and 230V wall charger.



NEW !

Reaching the World !

HF AMATEUR RADIO AND GENERAL COVERAGE
SHORTWAVE RECEIVER + VHF AIR BAND
ALL MODE : AM-NFM-WFM-USB-LSB

S-2000

SW (MHz)
1,7-30,0FM (MHz)
88-108MW (KHz)
520-1710LW (KHz)
100-519AIR (MHz)
118-137

Art. 50001020

**HF HAM RADIO AND GENERAL COVERAGE
SHORTWAVE RECEIVER + VHF AIR BAND**

Quality portable receiver for **HF/SW (SSB), MW, LW, FM and Aircraft Band (AM)**. Dual conversion for HF/SW, MW and LW. Professional construction with metal weighted knobs and keys. **Single side band (SSB) with USB & LSB**. Telescopic antenna for FM, AIR, HF & SW and 360° rotatable MW antenna. Multi external antenna jack. 1000 station memories, **BFO control for SSB, RF Gain, Squelch, Attenuator**. Power sources : 4 x UM1 (D size) batteries, 220VAC power, DC 6V. Auto Scan, manual tuning or direct frequency key-in function. Large backlighted LCD and analog Signal Meter.

Main Features

- > HF/SW 1.711-30.000 KHz
- > MW 520-1.710 KHz
- > LW 100-519 KHz
- > FM 88-108 MHz
- > Aircraft 118-137 MHz
- > Dual Conversion for HF/SW, LW, MW
- > AM, FM (Narrow/Wide) and Single Sideband (SSB) with USB & LSB
- > Auto Scan, Manual Tuning or direct frequency input by keypad
- > 1000 Station Memories
- > Clock and Dual Alarm Clock
- > Sleep Timer function
- > Telescopic Antenna for HF/SW, FM and Air Band
- > 360° Rotatable MW Antenna
- > RF Attenuator, Squelch, RF Gain
- > 10 cm quality built-in Speaker
- > Line-in/Line out jacks
- > Power sources : 4 x UM1 (D size) batteries, 220VAC , DC 6V **(230VAC adaptor included)**
- > Dimens. : 372 x 183 x 153 mm
- > Weight : 2.7 Kg

Wide backlighted LCD



Metal weighted knobs



Analog lighted meter



Rotatable MW antenna



External antennas jacks



PL-660

NEW!

HF AMATEUR RADIO AND GENERAL COVERAGE SHORTWAVE RECEIVER + VHF AIR BAND MODES : AM-FM-USB-LSB / 2000 MEMORIES

Art. 50001060

SW (MHz) 1,7-30,0

FM (MHz) 88-108

MW (KHz) 520-1710

LW (KHz) 100-519

AIR (MHz) 118-137



HF HAM RADIO AND GENERAL COVERAGE SHORTWAVE RECEIVER + VHF AIR BAND

Portable receiver for **HF/SW (SSB), MW, LW, FM and Aircraft Band (AM)**. Dual conversion for HF/SW, MW and LW. Single side band (SSB) with **USB & LSB Synchronous Detector with BFO control**. Telescopic antenna and external ant. jacks. 2000 memories, 9K/10K tuning steps for MW (AM), **DX/Normal/Local RF gain**. 4 tuning methods : ATS (Auto Tuning Storage), **Auto-Scan** with 5 sec. pre-listening, manual tuning or direct keypad entry. Large backlit LCD and digital Signal Meter. Power sources : 4 x AA batteries or DC 6V. Built-in charger for rechargeable batteries. Sleep timer (1-120 min.) and dual alarm clock with auto turn off (1-90 min.). **230VAC adaptor, soft carrying case and wire shortwave antenna included.**

Main Features

- > HF/SW 1.711-30.000 KHz
- > MW 522-1.620 KHz / LW 100-519 KHz
- > FM 88-108 MHz / Aircraft 118-137 MHz (AM)
- > Dual Conversion for HF/SW, LW, MW
- > AM, FM and Single Sideband (SSB) with USB & LSB
- > BFO control for SSB
- > ATS (Auto Tuning Storage), Auto-Scan with 5 sec. pre-listening, manual tuning or direct keypad entry
- > 2000 Preset Station Memories
- > Dual Alarm Clock with adjustable Auto Turn Off
- > Sleep Timer function (1-120 minutes)
- > DX/Normal/Local adjustable RF gain
- > 9K/10K frequency steps for MW (AM)
- > Dimensions : 181 x 116 x 36 mm

Soft Carrying Case

Ext. Antenna, Earset, DC IN

Tuning, VOL and BFO Controls



BCL-3000

NEW!

SHORTWAVE BROADCAST RECEIVER + VHF FM MODES : AM-FM / NARROW-WIDE BANDWIDTH

Art. 50001030

SW (MHz) 1,7-28,0

FM (MHz) 88-108

MW (KHz) 520-1710



GENERAL COVERAGE SHORTWAVE BROADCAST RECEIVER + VHF FM BAND + MW

Quality portable receiver for **SW broadcasting (SHORTWAVE)**, MW and VHF FM bands. Analog tuner with high sensitivity & selectivity. LCD display orange backlight, with digital Signal Meter. **Variable HF gain control**. Low-pass filter for SW and FM reception. Built-in telescopic antenna for SW and FM. Built-in ferrite antenna for AM. External antenna jacks. Digital clock display and alarm clock (with radio), Sleep Timer. Power sources : 4 x UM1 (D size) batteries or DC 6V (**230VAC adaptor included**). Strap type carrying handle.

Main Features

- > HF/SW 1.700-28.000 KHz
- > Continuous coverage from 3 to 28 MHz including 13 international broadcast bands (11, 13, 15, 16, 19, 22, 25, 31, 41, 49, 60, 75 and 90 Meters)
- > MW 520-1.610 KHz
- > FM 88-108 MHz
- > High sensitivity, selective tuner and digital frequency readout, variable RF Gain control
- > External antenna jack
- > Digital clock, wake up timer, radio-play alarm clock
- > Dimensions : 173 x 272 x 88 mm

NarrowWide Bandwidth Control

Metal Weighted Tuning Knob

Backlit LCD with S-Meter





RADIO COMMUNICATOR ANTENNAS

CB 27 MHz / VHF / UHF / MARINE / Accessories



World Leading Manufacturer of Communication Antennas

CB 27 MHz Mobile Antennas	pag. 38-43	UHF Mobile Antennas.....	pag. 46
CB 27 MHz Marine Antennas	pag. 44	Accessories	pag. 46
VHF Marine Antennas	pag. 44	Base Types / Whip Tuning Method.....	pag. 46
VHF Mobile Antennas.....	pag. 45-46	VHF Base Antennas	pag. 47

SANTIAGO 600

1200 W P.E.P.

155 CM

INOX STEEL WHIP

TYPE 5/8 λ

FREQUENCY 27 MHz

BAND WIDTH 600 KHz

IMPEDANCE 50 Ohm

S.W.R. < 1:1.2

MAX POWER 600 W RMS
1200 W P.E.P.

HEIGHT 1550 mm

MOUNTING HOLE \varnothing 16 mm

WHIP INOX STEEL

CABLE RG-58 4,5 m

RELATIVE GAIN 4 dB

BASE TYPE SO-239

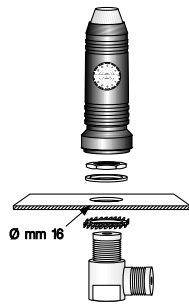
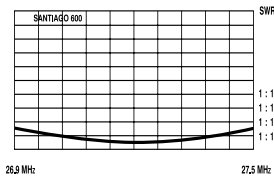

Art. 46005000

SANTIAGO 1200

2400 W P.E.P.

195 CM

INOX STEEL WHIP

TYPE 5/8 λ

FREQUENCY 26-28 MHz

BAND WIDTH 2000 KHz

IMPEDANCE 50 Ohm

S.W.R. < 1:1.2

MAX POWER 1200 W RMS
2400 W P.E.P.

HEIGHT 1950 mm

MOUNTING HOLE \varnothing 16 mm

WHIP INOX STEEL

CABLE RG-58 4,5 m

RELATIVE GAIN 5 dB

BASE TYPE SO-239

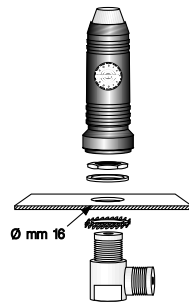
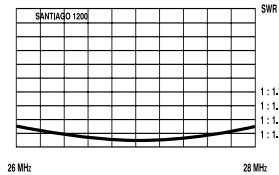

Art. 46005005

S60/A

150 W P.E.P.

68 CM

INOX STEEL WHIP

TYPE 1/4 λ

FREQUENCY 27 MHz

BAND WIDTH 500 KHz

IMPEDANCE 50 Ohm

S.W.R. < 1:1.2

MAX POWER 150 W P.E.P.

HEIGHT 680 mm

MOUNTING HOLE \varnothing 13 mm

WHIP INOX STEEL

CABLE RG-58 4,5 m

RELATIVE GAIN 2 dB

BASE TYPE N

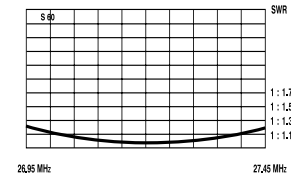

Art. 46005046

S60/A NV

150 W P.E.P.

68 CM

INOX STEEL WHIP

TYPE 1/4 λ

FREQUENCY 27 MHz

BAND WIDTH 500 KHz

IMPEDANCE 50 Ohm

S.W.R. < 1:1.2

MAX POWER 150 W P.E.P.

HEIGHT 680 mm

MOUNTING HOLE \varnothing 13 mm

WHIP INOX STEEL

CABLE RG-58 4,5 m

RELATIVE GAIN 2 dB

BASE TYPE NV

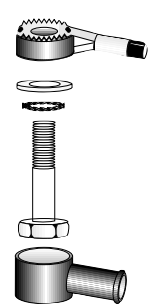
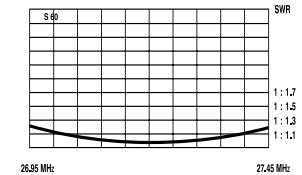

Art. 46005045

S90/A
150 W P.E.P.
98 CM
INOX STEEL WHIP
TYPE 1/4 λ
FREQUENCY 27 MHz

BAND WIDTH 600 KHz

IMPEDANCE 50 Ohm

S.W.R. < 1:1.1

MAX POWER 150 W P.E.P.

HEIGHT 980 mm

MOUNTING HOLE \varnothing 13 mm

WHIP INOX STEEL

CABLE RG-58 4.5 m

RELATIVE GAIN 3 dB

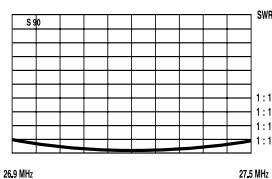
BASE TYPE N

26.9 MHz

27.5 MHz

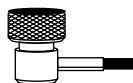
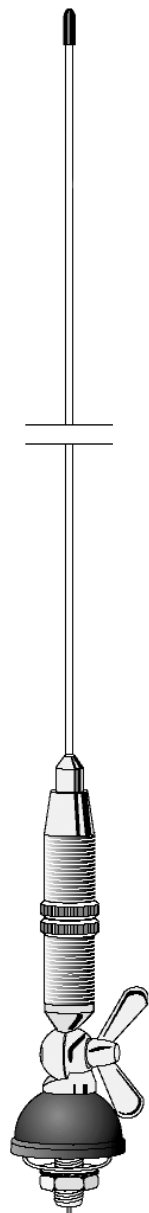

Art. 46005051

S90/A NV
150 W P.E.P.
98 CM
INOX STEEL WHIP
TYPE 1/4 λ
FREQUENCY 27 MHz

BAND WIDTH 600 KHz

IMPEDANCE 50 Ohm

S.W.R. < 1:1.1

MAX POWER 150 W P.E.P.

HEIGHT 980 mm

MOUNTING HOLE \varnothing 13 mm

WHIP INOX STEEL

CABLE RG-58 4.5 m

RELATIVE GAIN 3 dB

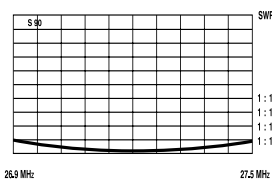
BASE TYPE NV

26.9 MHz

27.5 MHz

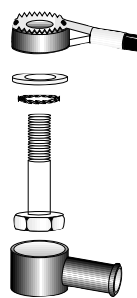

Art. 46005050

S9 PLUS
200 W P.E.P.
150 CM
INOX STEEL WHIP
TYPE 5/8 λ
FREQUENCY 26-28 MHz

BAND WIDTH 2000 KHz

IMPEDANCE 50 Ohm

S.W.R. < 1:1.4

MAX POWER 200 W P.E.P.

HEIGHT 1500 mm

MOUNTING HOLE \varnothing 13 mm

WHIP INOX STEEL

CABLE RG-58 4.5 m

RELATIVE GAIN 4 dB

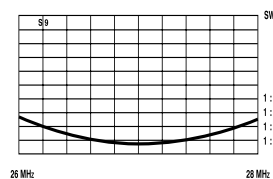
BASE TYPE N

26 MHz

28 MHz

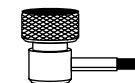

Art. 46005026

S9 PLUS NV
200 W P.E.P.
150 CM
INOX STEEL WHIP
TYPE 5/8 λ
FREQUENCY 26-28 MHz

BAND WIDTH 2000 KHz

IMPEDANCE 50 Ohm

S.W.R. < 1:1.4

MAX POWER 200 W P.E.P.

HEIGHT 1500 mm

MOUNTING HOLE \varnothing 13 mm

WHIP INOX STEEL

CABLE RG-58 4.5 m

RELATIVE GAIN 4 dB

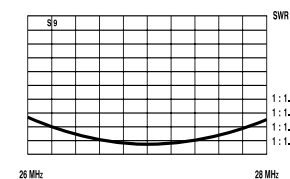
BASE TYPE NV

26 MHz

28 MHz

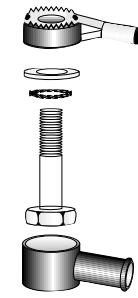
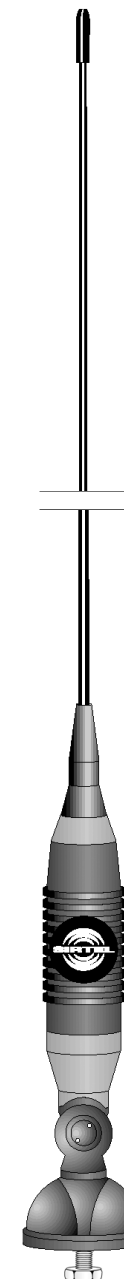

Art. 46005025

GAMMA 2R

300 W P.E.P.

92 CM

FIBERGLASS WHIP

TYPE 5/8 λ
FREQUENCY 27 MHz
BAND WIDTH 1200 KHz
IMPEDANCE 50 Ohm
S.W.R. < 1:1.2
MAX POWER 300 W P.E.P.
HEIGHT 920 mm
MOUNTING HOLE \varnothing 13 mm
WHIP FIBERGLASS
CABLE RG-58 4.5 m
RELATIVE GAIN 2.5 dB
BASE TYPE N

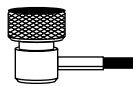
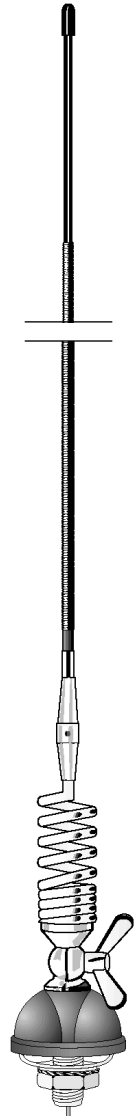
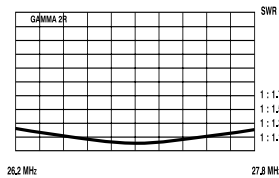

Art. 46005036

GAMMA 2R NV

300 W P.E.P.

92 CM

FIBERGLASS WHIP

TYPE 5/8 λ
FREQUENCY 27 MHz
BAND WIDTH 1200 KHz
IMPEDANCE 50 Ohm
S.W.R. < 1:1.2
MAX POWER 300 W P.E.P.
HEIGHT 920 mm
MOUNTING HOLE \varnothing 13 mm
WHIP FIBERGLASS
CABLE RG-58 4.5 m
RELATIVE GAIN 2.5 dB
BASE TYPE NV

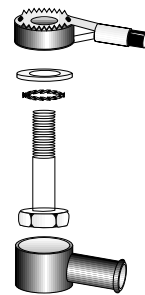
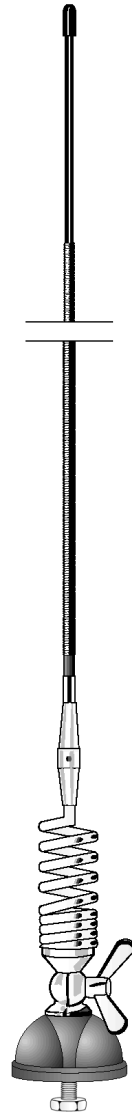
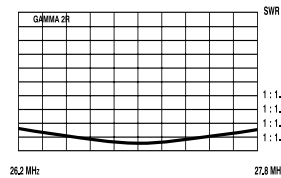

Art. 46005035

GAMMA 1R

300 W P.E.P.

126 CM

FIBERGLASS WHIP

TYPE 5/8 λ
FREQUENCY 27 MHz
BAND WIDTH 1200 KHz
IMPEDANCE 50 Ohm
S.W.R. < 1:1.2
MAX POWER 300 W P.E.P.
HEIGHT 1260 mm
MOUNTING HOLE \varnothing 13 mm
WHIP FIBERGLASS
CABLE RG-58 4.5 m
RELATIVE GAIN 3 dB
BASE TYPE N

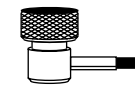
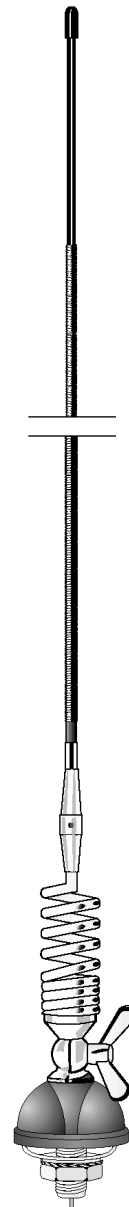
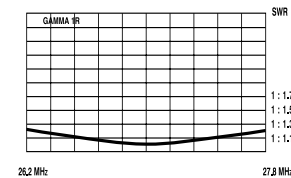

Art. 46005029

GAMMA 1R NV

300 W P.E.P.

126 CM

FIBERGLASS WHIP

TYPE 5/8 λ
FREQUENCY 27 MHz
BAND WIDTH 1200 KHz
IMPEDANCE 50 Ohm
S.W.R. < 1:1.2
MAX POWER 300 W P.E.P.
HEIGHT 1260 mm
MOUNTING HOLE \varnothing 13 mm
WHIP FIBERGLASS
CABLE RG-58 4.5 m
RELATIVE GAIN 3 dB
BASE TYPE NV

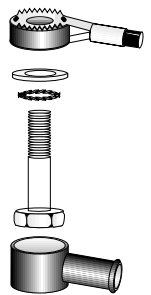
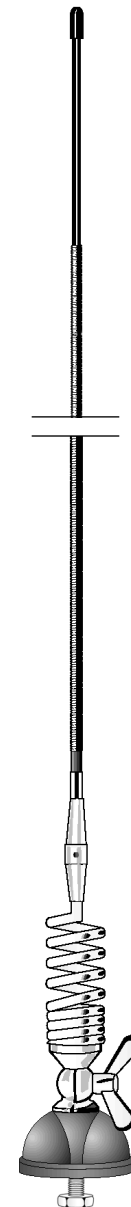
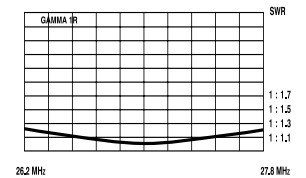

Art. 46005032

GAMMA 2
300 W P.E.P.
98 CM
FIBERGLASS WHIP

TYPE 5/8 λ
FREQUENCY 27 MHz
BAND WIDTH 1200 KHz
IMPEDANCE 50 Ohm
S.W.R. < 1:1.2
MAX POWER 300 W P.E.P.
HEIGHT 980 mm
MOUNTING HOLE \varnothing 13 mm
WHIP FIBERGLASS
CABLE RG-58 4.5 m
RELATIVE GAIN 3 dB
BASE TYPE N

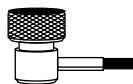
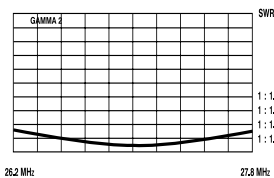

Art. 46005031

GAMMA 2 NV
300 W P.E.P.
98 CM
FIBERGLASS WHIP

TYPE 5/8 λ
FREQUENCY 27 MHz
BAND WIDTH 1200 KHz
IMPEDANCE 50 Ohm
S.W.R. < 1:1.2
MAX POWER 300 W P.E.P.
HEIGHT 980 mm
MOUNTING HOLE \varnothing 13 mm
WHIP FIBERGLASS
CABLE RG-58 4.5 m
RELATIVE GAIN 3 dB
BASE TYPE NV

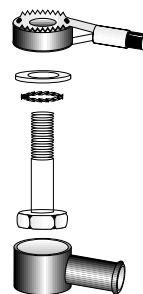
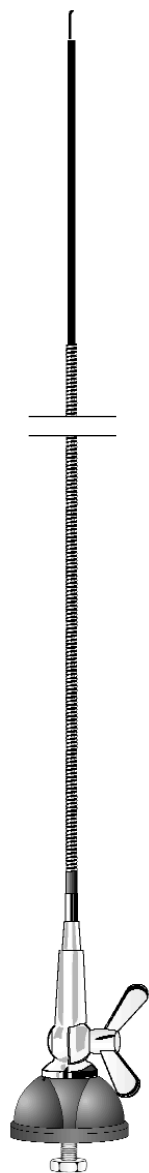
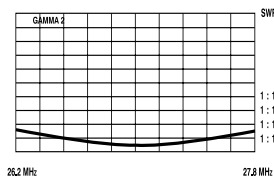

Art. 46005030

GAMMA 1
300 W P.E.P.
124 CM
FIBERGLASS WHIP

TYPE 5/8 λ
FREQUENCY 27 MHz
BAND WIDTH 1200 KHz
IMPEDANCE 50 Ohm
S.W.R. < 1:1.2
MAX POWER 300 W P.E.P.
HEIGHT 1240 mm
MOUNTING HOLE \varnothing 13 mm
WHIP FIBERGLASS
CABLE RG-58 4.5 m
RELATIVE GAIN 3 dB
BASE TYPE N

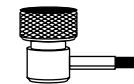
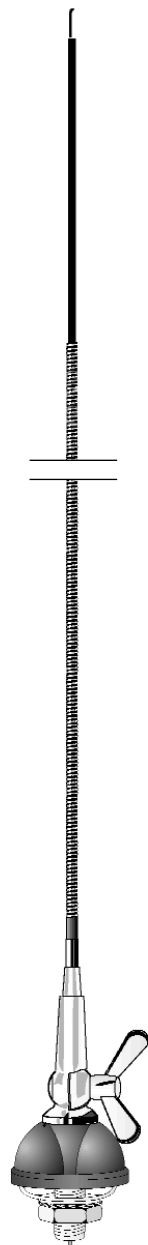
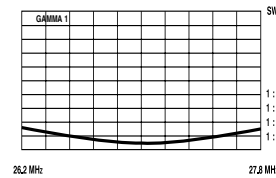

Art. 46005028

GAMMA 1 NV
300 W P.E.P.
124 CM
FIBERGLASS WHIP

TYPE 5/8 λ
FREQUENCY 27 MHz
BAND WIDTH 1200 KHz
IMPEDANCE 50 Ohm
S.W.R. < 1:1.2
MAX POWER 300 W P.E.P.
HEIGHT 1240 mm
MOUNTING HOLE \varnothing 13 mm
WHIP FIBERGLASS
CABLE RG-58 4.5 m
RELATIVE GAIN 3 dB
BASE TYPE NV

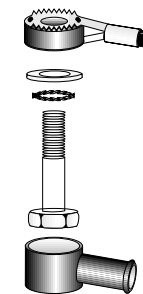
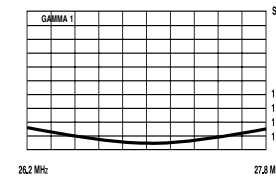

Art. 46005027

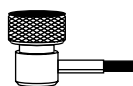
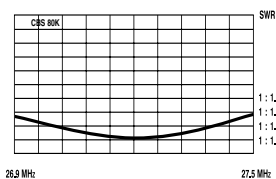
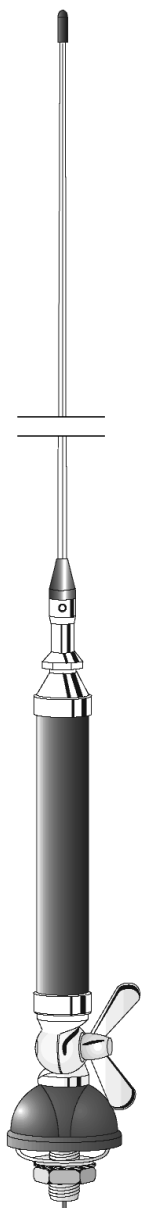
CBS 80K**200 W P.E.P.****145 CM****INOX STEEL WHIP****TYPE** 5/8 λ **FREQUENCY** 27 MHz**BAND WIDTH** 400 KHz**IMPEDANCE** 50 Ohm**S.W.R.** < 1:1.2**MAX POWER** 200 W P.E.P.**HEIGHT** 1450 mm**MOUNTING HOLE** \varnothing 13 mm**WHIP** INOX STEEL**CABLE** RG-58 4.5 m**RELATIVE GAIN** 5 dB**BASE TYPE** N

Art. 46005040

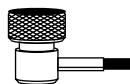
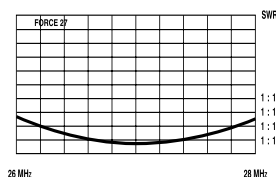
FORCE 27 C**100 W P.E.P.****94 CM****INOX STEEL WHIP****TYPE** 1/4 λ **FREQUENCY** 27 MHz**BAND WIDTH** 800 KHz**IMPEDANCE** 50 Ohm**S.W.R.** < 1:1.5**MAX POWER** 100 W P.E.P.**HEIGHT** 940 mm**MOUNTING HOLE** \varnothing 9 mm**WHIP** BLACK INOX STEEL**CABLE** RG-58 4.5 m**RELATIVE GAIN** 3 dB**BASE TYPE** N

Art. 46005137

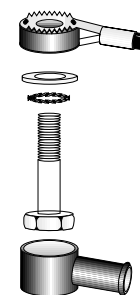
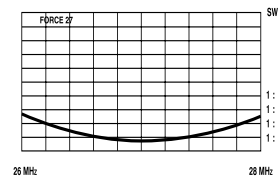
FORCE 27 NV**100 W P.E.P.****94 CM****INOX STEEL WHIP****TYPE** 1/4 λ **FREQUENCY** 27 MHz**BAND WIDTH** 800 KHz**IMPEDANCE** 50 Ohm**S.W.R.** < 1:1.5**MAX POWER** 100 W P.E.P.**HEIGHT** 940 mm**MOUNTING HOLE** \varnothing 9 mm**WHIP** BLACK INOX STEEL**CABLE** RG-58 4.5 m**RELATIVE GAIN** 3 dB**BASE TYPE** NV

Art. 46005136

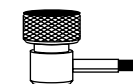
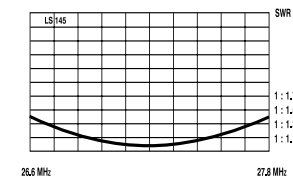
LS 145/M**400 W P.E.P.****150 CM****INOX STEEL WHIP****TYPE** 5/8 λ **FREQUENCY** 26-28 MHz**BAND WIDTH** 1200 KHz**IMPEDANCE** 50 Ohm**S.W.R.** < 1:1.3**MAX POWER** 400 W P.E.P.**HEIGHT** 980 mm**MOUNTING HOLE** \varnothing 13 mm**WHIP** INOX STEEL**CABLE** RG-58 4.5 m**RELATIVE GAIN** 3,5 dB**BASE TYPE** N

Art. 46005020

COUNTRY 27/A
50 W P.E.P.
150 CM
INOX STEEL WHIP
TYPE 1/2 λ REDUCED

FREQUENCY 26-28 MHz

BAND WIDTH 2000 KHz

IMPEDANCE 50 Ohm

S.W.R. < 1:1.2

MAX POWER 50 W P.E.P.

HEIGHT 1500 mm

MOUNTING L BRACKET INCLUDED

WHIP INOX STEEL

CABLE RG-58 4.5 m WHITE COLOR

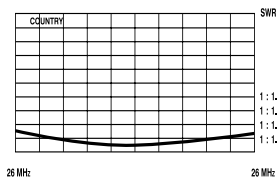
RELATIVE GAIN 4 dB

**4.5 MT RG-58U
WHITE COLOR CABLE
INCLUDED AND
DIRECTLY CONNECTED
TO THE ANTENNA**

Art. 46005055

OVERLAND CANADA 1000
200 W P.E.P.
110 CM
INOX STEEL WHIP
TYPE 5/8 λ
FREQUENCY 27 MHz

BAND WIDTH 800 KHz

IMPEDANCE 50 Ohm

S.W.R. < 1:1.2

MAX POWER 200 W P.E.P.

HEIGHT 1110 mm

MOUNTING HOLE \varnothing 8.5 mm

WHIP BLACK CHROMED INOX STEEL

CABLE RG-58 4.5 m

RELATIVE GAIN 3 dB

BASE TYPE NV

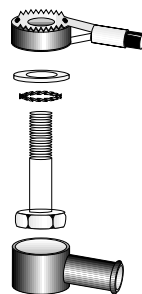
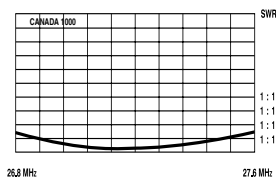
MOVEMENT FOLDABLE 90°

Art. 46009000

OVERLAND AMERICA 2000
300 W P.E.P.
153 CM
INOX STEEL WHIP
TYPE 5/8 λ
FREQUENCY 27 MHz

BAND WIDTH 2000 KHz

IMPEDANCE 50 Ohm

S.W.R. < 1:1.2

MAX POWER 300 W P.E.P.

HEIGHT 1530 mm

MOUNTING HOLE \varnothing 8.5 mm

WHIP BLACK CHROMED INOX STEEL

CABLE RG-58 4.5 m

RELATIVE GAIN 4 dB

BASE TYPE NV

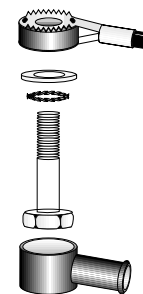
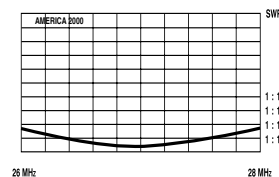
MOVEMENT FOLDABLE 90°

Art. 46009010

OVERLAND AUSTRALIA 27
200 W P.E.P.
150 CM
INOX STEEL WHIP
TYPE 5/8 λ
FREQUENCY 26-28 MHz

BAND WIDTH 2000 KHz

IMPEDANCE 50 Ohm

S.W.R. < 1:1.4

MAX POWER 200 W P.E.P.

HEIGHT 1500 mm

MOUNTING HOLE \varnothing 13 mm

WHIP BLACK CHROMED INOX STEEL

CABLE RG-58 4.5 m

RELATIVE GAIN 4 dB

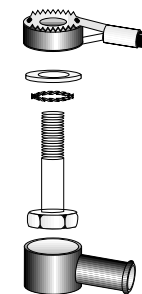
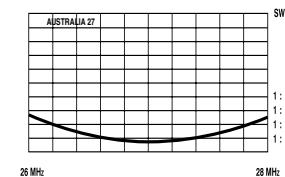
BASE TYPE NV

Art. 46009020

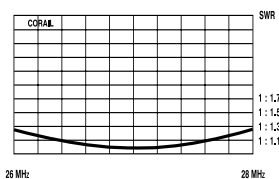
CORAIL 2000**50 W P.E.P.****168 CM****FIBERGLASS WHIP****TYPE** 1/2 λ **FREQUENCY** 26-28 MHz**BAND WIDTH** 2000 KHz**IMPEDANCE** 50 Ohm**S.W.R.** < 1:1.2**MAX POWER** 50 W P.E.P.**HEIGHT** 1680 mm**MOUNTING** NYLON BRACKET**WHIP TYPE** FIBERGLASS**CABLE** RG-58 5 m WHITE COLOR**RELATIVE GAIN** 4 dB**WHIP ADJUST** FOLDABLE 4 AXES

5.0 MT RG-58U
WHITE COLOR CABLE
INCLUDED AND
DIRECTLY CONNECTED
TO THE ANTENNA

Art. 46005070

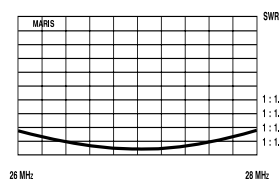
MARIS 2000**50 W P.E.P.****157 CM****FIBERGLASS WHIP****TYPE** 1/2 λ **FREQUENCY** 26-28 MHz**BAND WIDTH** 2000 KHz**IMPEDANCE** 50 Ohm**S.W.R.** < 1:1.2**MAX POWER** 50 W P.E.P.**HEIGHT** 1570 mm**MOUNTING** L BRACKET INCLUDED**WHIP** FIBERGLASS**CABLE** RG-58 5 m WHITE COLOR**RELATIVE GAIN** 3.5 dB

5.0 MT RG-58U
WHITE COLOR CABLE
INCLUDED AND
DIRECTLY CONNECTED
TO THE ANTENNA

Art. 46005075

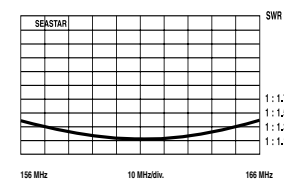
SEASTAR**100 W****132 CM****FIBERGLASS WHIP****TYPE** 5/8 λ **FREQUENCY** 156-166 MHz**BAND WIDTH** 10 MHz**IMPEDANCE** 50 Ohm**S.W.R.** < 1:1.1**MAX POWER** 100 W**HEIGHT** 1320 mm**MOUNTING** NYLON BRACKET**WHIP TYPE** FIBERGLASS**CABLE** RG-58 5 m WHITE COLOR**RELATIVE GAIN** 3 dB**WHIP ADJUST** FOLDABLE 4 AXES

5.0 MT RG-58U
WHITE COLOR CABLE
INCLUDED AND
DIRECTLY CONNECTED
TO THE ANTENNA

Art. 46005085

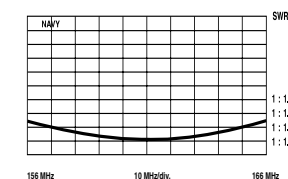
NAVY**50 W****120 CM****FIBERGLASS WHIP****TYPE** 5/8 λ **FREQUENCY** 156-166 MHz**BAND WIDTH** 10 MHz**IMPEDANCE** 50 Ohm**S.W.R.** < 1:1.1**MAX POWER** 100 W**HEIGHT** 1200 mm**MOUNTING** L BRACKET INCLUDED**WHIP** FIBERGLASS**CABLE** RG-58 5 m WHITE COLOR**RELATIVE GAIN** 3 dB

5.0 MT RG-58U
WHITE COLOR CABLE
INCLUDED AND
DIRECTLY CONNECTED
TO THE ANTENNA

Art. 46005080

LT 4

100 W / 54 CM

INOX STEEL WHIP

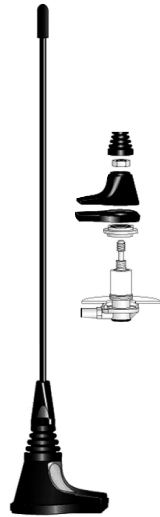

TYPE 1/4 λ
FREQUENCY 144-174 MHz
BAND WIDTH 9 MHz
IMPEDANCE 50 Ohm
S.W.R. < 1:1.5
MAX POWER 100 W
HEIGHT 540 mm
MOUNTING HOLE Ø 19 mm
WHIP BLACK INOX STEEL
CABLE RG-58 4.5 m
RELATIVE GAIN 0 dB
BASE TYPE LT

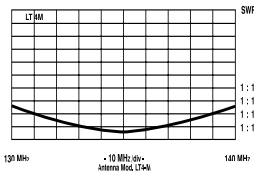

Art. 46005130

SM A4

100 W / 53 CM

INOX STEEL WHIP

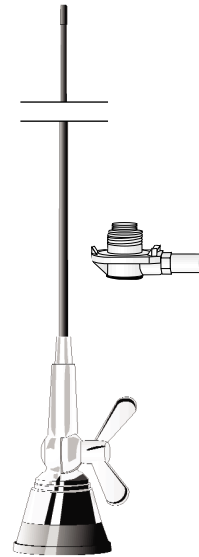

TYPE 1/4 λ
FREQUENCY 144-174 MHz
BAND WIDTH 9 MHz
IMPEDANCE 50 Ohm
S.W.R. < 1:1.5
MAX POWER 100 W
HEIGHT 535 mm
MOUNTING HOLE Ø 19 mm
WHIP INOX STEEL
CABLE RG-58 4.5 m
RELATIVE GAIN 0 dB
BASE TYPE S

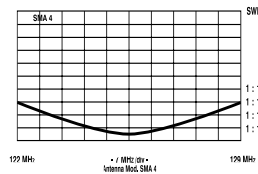

Art. 46005100

SL A4

100 W / 58 CM

INOX STEEL WHIP

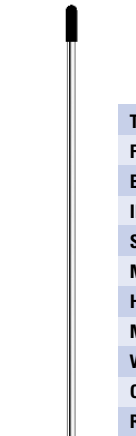

TYPE 1/4 λ
FREQ. 144-174 MHz
BAND WIDTH 7 MHz
IMPEDANCE 50 Ohm
S.W.R. < 1:1.5
MAX POWER 100 W
HEIGHT 580 mm
MOUNT HOLE Ø 19 mm
WHIP INOX STEEL
CABLE RG-58 4.5 m
RELATIVE GAIN 0 dB
BASE TYPE L

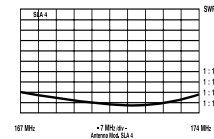

Art. 46005105

SL A4M

100 W / 53 CM

INOX STEEL WHIP

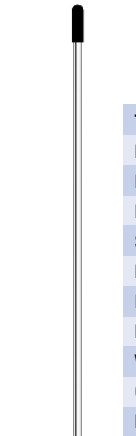

TYPE 1/4 λ
FREQ. 144-174 MHz
BAND WIDTH 7 MHz
IMPEDANCE 50 Ohm
S.W.R. < 1:1.5
MAX POWER 100 W
HEIGHT 535 mm
MOUNT HOLE Ø 19 mm
WHIP INOX STEEL
CABLE RG-58 4.5 m
RELATIVE GAIN 0 dB
BASE TYPE L

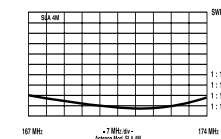

Art. 46005090

MLA 75C

100 W / 126 CM

INOX STEEL WHIP

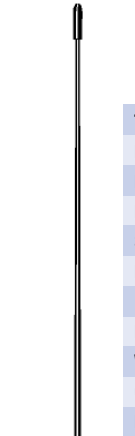

TYPE 1/4 λ
FREQUENCY 66-88 MHz
BAND WIDTH 4 MHz
IMPEDANCE 50 Ohm
S.W.R. < 1:1.5
MAX POWER 100 W
HEIGHT 1260 mm
MOUNT Ø 19 mm
WHIP BLACK INOX STEEL
CABLE RG-58 4.5 m
RELATIVE GAIN 0 dB
BASE TYPE L

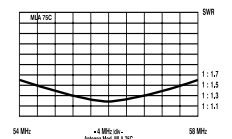

Art. 46005120

TORNADO VHF

250 W

55 CM

INOX STEEL WHIP

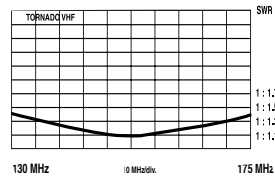

Art. 46005135

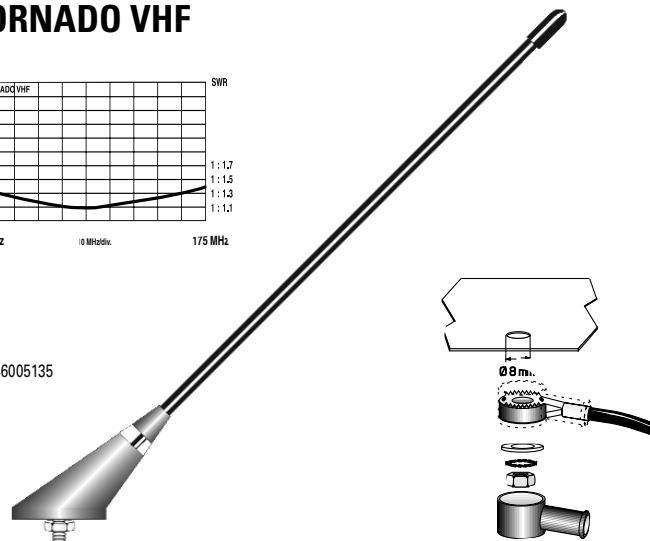

TYPE 1/4 λ
FREQUENCY 130-175 MHz
BAND WIDTH 9 MHz
IMPEDANCE 50 Ohm
S.W.R. < 1:1.5
MAX POWER 250 W
HEIGHT 555 mm
MOUNTING HOLE Ø 13.5 mm
WHIP INOX STEEL
CABLE RG-58 4.5 m
RELATIVE GAIN 0 dB
BASE TYPE E

SL A2C

100 W

142 CM

INOX STEEL WHIP

TYPE 5/8 λ

FREQUENCY 144-174 MHz

BAND WIDTH 7 MHz

IMPEDANCE 50 Ohm

S.W.R. < 1:1.5

MAX POWER 100 W

HEIGHT 1425 mm

MOUNTING HOLE Ø 19 mm

WHIP INOX STEEL

CABLE RG-58 4.5 m

RELATIVE GAIN 1.8 dB

BASE TYPE L

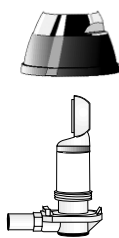
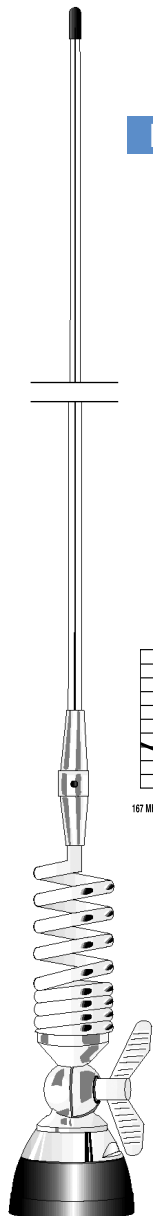
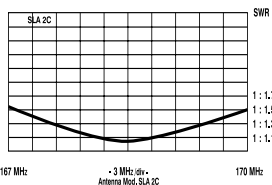

Art. 46005095

LT U2

100W / 20 CM

INOX STEEL WHIP

TYPE 1/4 λ

FREQUENCY 400-470 MHz

BANDWIDTH 7 MHz

IMPEDANCE 50 Ohm

S.W.R. < 1:1.5

MAX POWER 100 W

HEIGHT 205 mm

MOUNTING HOLE Ø 19 mm

WHIP BLACK INOX STEEL

CABLE RG-58 4.5 m

RELATIVE GAIN 0 dB

BASE TYPE LT

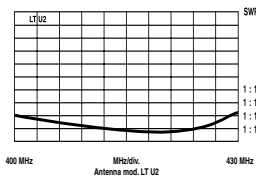

Art. 46008040

SH 918

50 W / 8 CM

BLACK POLIACETALIC RESIN RADOME

TYPE 1/4 λ DOUBLE BAND

FREQ. 870-960/1710-1880 MHz

IMPEDANCE 50 Ohm

S.W.R. < 1:1.5

MAX POWER 50 W

HEIGHT 82 mm

HOLE Ø 18mm out / 14mm inside

INTERNAL WHIP STEEL

RADOME BLACK ACETALIC RESIN

CABLE RG-58 4.5 m

RELATIVE GAIN 2.14 dB

CONNECTOR FME MALE

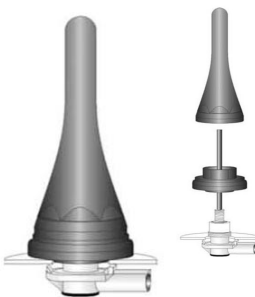
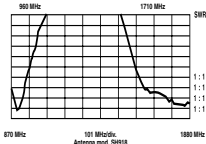

Art. 46008345

MOD. SP

MIRROR MOUNT

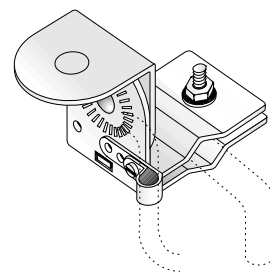

MIRROR MOUNT ADJUSTABLE BRACKET HOLE DIAMETER mm 12.5 FOR "N" AND "NV" TYPE BASES

Art. 46005181

MOD. TM

TRUNK MOUNT

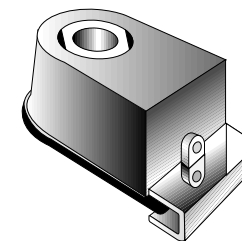

TRUNK MOUNT BRACKET ADAPTORS INCLUDED FOR "N", "NV", "S", "L", "SO-239" BASES

Art. 46005180

BASE TYPES

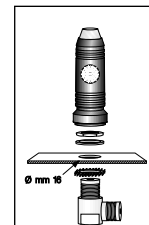

TYPE "S0-239"

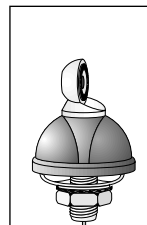

TYPE "N"

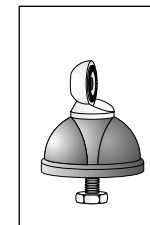

TYPE "NV"

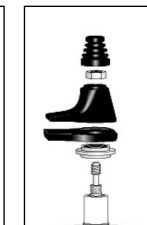

TYPE "LT"

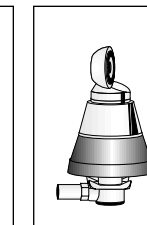

TYPE "S"

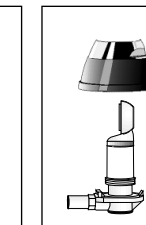

TYPE "L"

WHIP TUNING METHOD

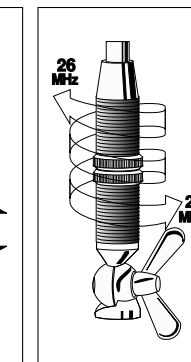
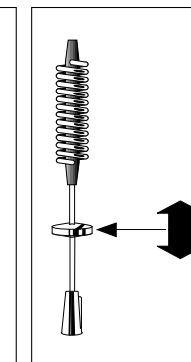
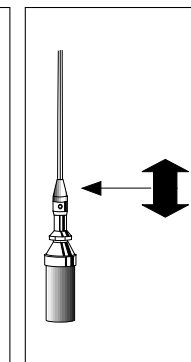
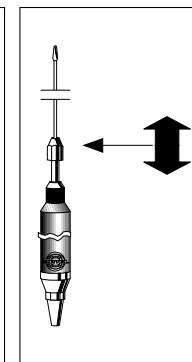
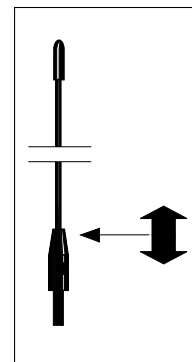

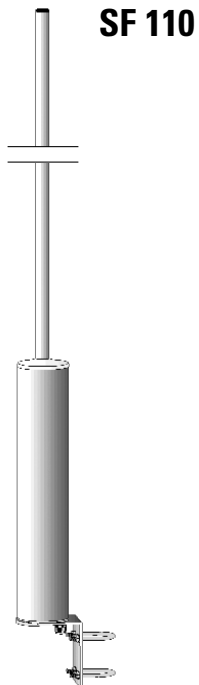

SF 110 ANODIZED ALUMINUM 200W / 130 ÷ 150 CM

TYPE 3/4 λ

FREQUENCY RANGE :

143-148 MHz (SF 110/A) (Art. 46008037)

146-151 MHz (SF 110/B) (Art. 46008032)

149-154 MHz (SF 110/D) (Art. 46008038)

153-158 MHz (SF 110/E) (Art. 46008039)

157-162 MHz (SF 110/F) (Art. 46008035)

161-166 MHz (SF 110/G) (Art. 46008036)

165-170 MHz (SF 110/H) (Art. 46008034)

169-174 MHz (SF 110/I) (Art. 46008033)

BAND WIDTH 5 MHz **S.W.R.** < 1:1.5

IMPEDANCE 50 Ohm **POLARIS.** VERTICAL

BEAM WIDTH -3dB 64° **BEAM TILT** 15°

RELATIVE GAIN 2 dBd **MAX POWER** 200 W

CONNECTOR UHF FEMALE **WEIGHT** 660 Gr.

MOUNTING FROM 30 TO 40 mm (MASTER TUBE)

RADIATOR MATERIAL ANODIZED ALUMINUM

CLAMP MATERIAL INOX STEEL AISI 304

RADIATOR HEIGHT FROM 1300 TO 1500 mm

WIND RESISTANCE 120 Km/h

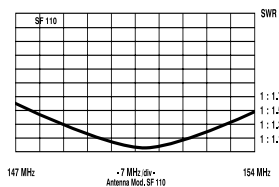

SY 153 ANODIZED ALUMINUM 200W / 115 x 110 CM

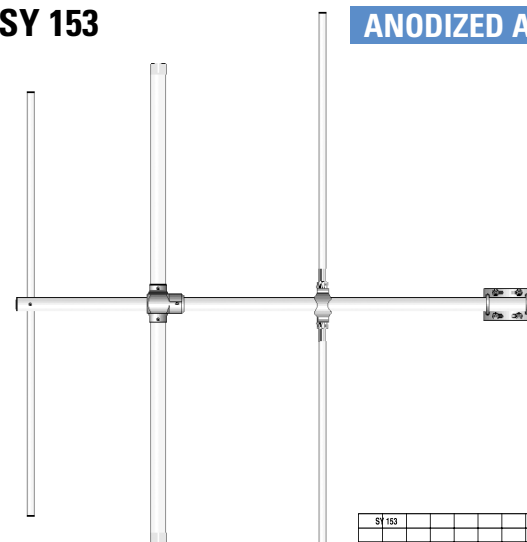

ANODIZED ALUMINUM 200W / 115 x 110 CM

TYPE YAGI 3 ELEMENTS

FREQUENCY RANGE 144-175 MHz

BAND WIDTH 31 MHz

IMPEDANCE 50 Ohm

S.W.R. < 1:1.6

POLARISATION HORIZONTAL OR VERTICAL

BEAM WIDTH -3dB H PLANE 70°
E PLANE 140°

FRONT TO BACK RATIO H PLANE -17 dB
E PLANE -18 dB

RELATIVE GAIN 5.5 dBd

MAX POWER 200 W

CONNECTOR N FEMALE

MOUNTING FROM 30 TO 62 mm (MASTER TUBE)

BOOM MATERIAL ANODIZED ALUMINUM

ELEMENTS MATERIAL ANODIZED ALUMINUM

ANCHOR CLAMP INOX STEEL AISI 304

SIZE 1150 x 1110 mm **WEIGHT** 3.6 KG

WIND RESISTANCE 120 Km/h

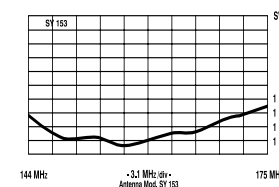

Art. 46005151

SY 152

ANODIZED ALUMINUM 200 W / 115 x 79 CM

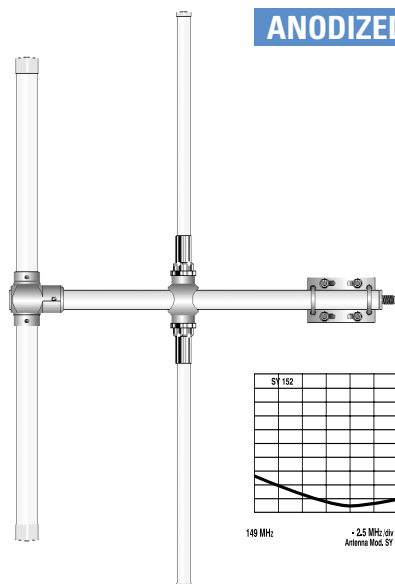

TYPE YAGI 2 ELEMENTS

FREQUENCY RANGE 149-174 MHz

BAND WIDTH 25 MHz

IMPEDANCE 50 Ohm **S.W.R.** < 1:1.5

POLARISATION HORIZONTAL OR VERTICAL

BEAM WIDTH -3dB H PLANE 77°
E PLANE 190°

FRONT TO BACK RATIO H PLANE -10dB
E PLANE -15dB

RELATIVE GAIN 3 dBd **MAX POWER** 200 W

CONNECTOR N FEMALE

MOUNTING FROM 30 TO 60 mm (MASTER TUBE)

BOOM MATERIAL ANODIZED ALUMINUM

ELEMENTS MATERIAL ANODIZED ALUMINUM

ANCHOR CLAMP INOX STEEL AISI 304

SIZE 1150 x 790 mm **WEIGHT** 3.3 KG

WIND RESISTANCE 120 Km/h

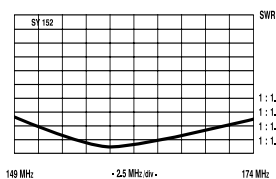

Art. 46005150

SY 154 H

ANODIZED ALUMINUM 200W / 130 x 99 CM

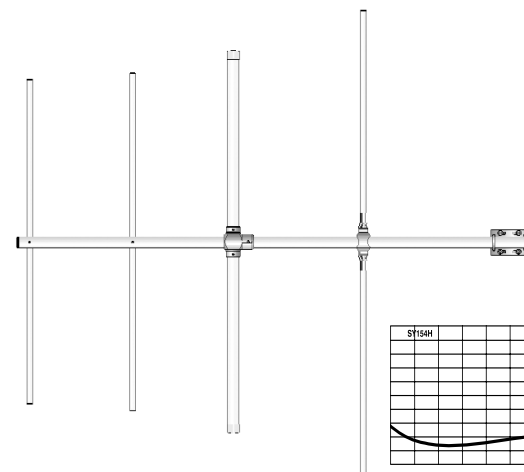

TYPE YAGI 4 ELEMENTS

FREQUENCY RANGE 156-174 MHz

BAND WIDTH 18 MHz

IMPEDANCE 50 Ohm **S.W.R.** < 1:1.5

POLARISATION HORIZONTAL OR VERTICAL

BEAM WIDTH -3dB H PLANE 78°/E PLANE 53°
E PLANE -20 dB

FRONT TO BACK RATIO H PLANE -14 dB
E PLANE -20 dB

RELATIVE GAIN 7 dBd **MAX POWER** 200 W

CONNECTOR N FEMALE

MOUNTING FROM 30 TO 62 mm (MASTER TUBE)

BOOM MATERIAL ANODIZED ALUMINUM

ELEMENTS MATERIAL ANODIZED ALUMINUM

ANCHOR CLAMP INOX STEEL AISI 304

SIZE 1300 x 995 mm **WEIGHT** 2.8 KG

WIND RESISTANCE 120 Km/h

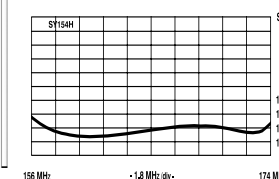

Art. 46005152

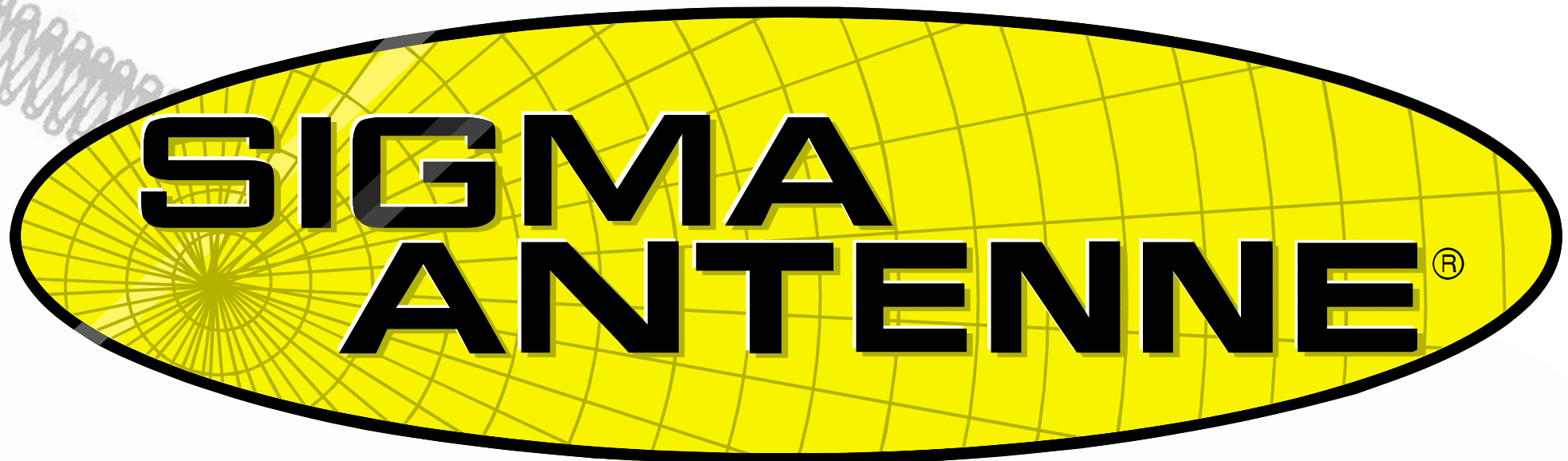

RADIO COMMUNICATON ANTENNAS

CB 27 MHz / VHF / UHF / MARINE / 43 MHz / Accessories



World Leading Manufacturer of Communication Antennas

CB 27 MHz Mobile Antennas	pag. 49-52	UHF Mobile Antennas.....	pag. 56
CB 27 MHz Base Antennas.....	pag. 53-54	VHF Base Antennas	pag. 57-58
CB 27 MHz Marine Antennas	pag. 55	43 MHz Mobile Antennas	pag. 58-59
VHF Marine Antennas	pag. 55	43 MHz Base Antennas.....	pag. 59
VHF Mobile Antennas.....	pag. 56	Accessories	pag. 60

PLC 600 L
600 W P.E.P.
125 CM
INOX STEEL WHIP

FREQUENCY 27 MHz
IMPEDANCE 50 Ohm
S.W.R. ≤ 1.1 AT CENTER FREQ.
MAX POWER 600 W P.E.P.
HEIGHT 1250 mm
WEIGHT 700 Gr.
MOUNTING HOLE Ø 10 mm
WHIP 17.7 PH INOX STEEL
CABLE RG-58U 5 m
RELATIVE GAIN 4 dB
BASE SHORTED TO GROUND

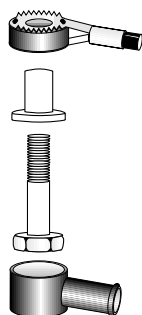
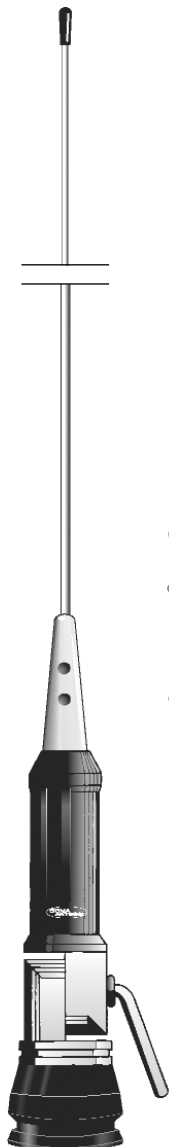
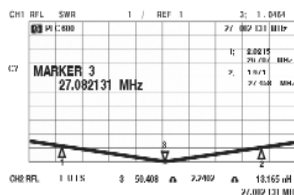

Art. 46000005

PLC 800 INOX
800 W P.E.P.
165 CM
INOX STEEL WHIP

FREQUENCY 27 MHz
IMPEDANCE 50 Ohm
S.W.R. ≤ 1.1 AT CENTER FREQ.
MAX POWER 800 W P.E.P.
HEIGHT 1650 mm
WEIGHT 700 Gr.
MOUNTING HOLE Ø 10 mm
WHIP 17.7 PH INOX STEEL
CABLE RG-58U 5 m
RELATIVE GAIN 4.5 dB
BASE SHORTED TO GROUND

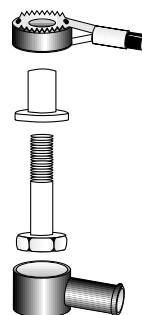
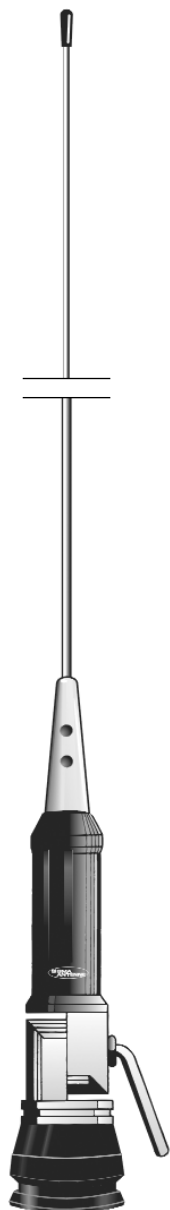
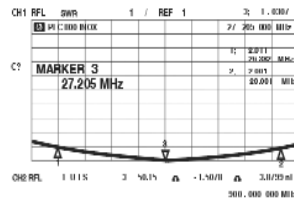

Art. 46000015

PLC 1000 INOX
1000 W P.E.P.
190 CM
INOX STEEL WHIP

FREQUENCY 27 MHz
IMPEDANCE 50 Ohm
S.W.R. ≤ 1.1 AT CENTER FREQ.
MAX POWER 1000 W P.E.P.
HEIGHT 1900 mm
WEIGHT 800 Gr.
MOUNTING HOLE Ø 10 mm
WHIP 17.7 PH INOX STEEL
CABLE RG-58U 5 m
RELATIVE GAIN 5 dB
BASE SHORTED TO GROUND

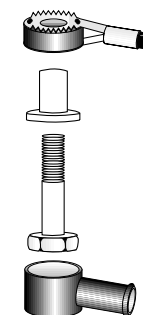

Art. 46000010

PLC 600 S
600 W P.E.P.
115 CM
INOX STEEL WHIP

FREQUENCY 27 MHz
IMPEDANCE 50 Ohm
S.W.R. ≤ 1.1 AT CENTER FREQ.
MAX POWER 600 W P.E.P.
HEIGHT 1150 mm
WEIGHT 700 Gr.
MOUNTING HOLE Ø 10 mm
WHIP 17.7 PH INOX STEEL
CABLE RG-58U 5 m
RELATIVE GAIN 4 dB
BASE SHORTED TO GROUND

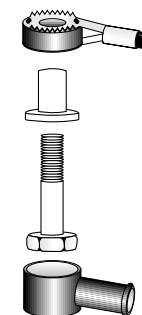
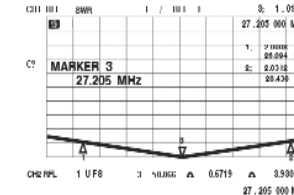

Art. 46000000

PLC MINOX S**400 W P.E.P.****75 CM****INOX STEEL WHIP**

FREQUENCY 27 MHz
IMPEDANCE 50 Ohm
S.W.R. ≤ 1.1 AT CENTER FREQ.
MAX POWER 400 W P.E.P.
HEIGHT 750 mm
WEIGHT 700 Gr.
MOUNTING HOLE \varnothing 10 mm
WHIP 17.7 PH INOX STEEL
CABLE RG-58U 5 m
RELATIVE GAIN 3.5 dB
BASE SHORTED TO GROUND

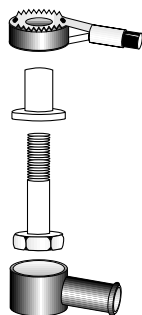
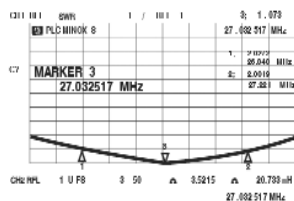

Art. 46000025

PLC MINOX L**400 W P.E.P.****90 CM****INOX STEEL WHIP**

FREQUENCY 27 MHz
IMPEDANCE 50 Ohm
S.W.R. ≤ 1.1 AT CENTER FREQ.
MAX POWER 400 W P.E.P.
HEIGHT 900 mm
WEIGHT 700 Gr.
MOUNTING HOLE \varnothing 10 mm
WHIP 17.7 PH INOX STEEL
CABLE RG-58U 5 m
RELATIVE GAIN 3.5 dB
BASE SHORTED TO GROUND

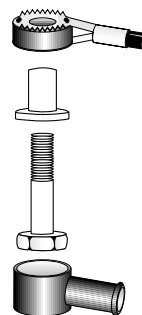
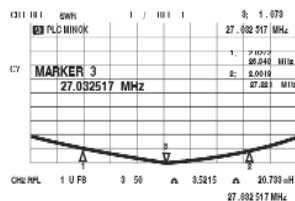

Art. 46000030

CAMPER 27**100 W P.E.P.****100 CM****FIBERGLASS WHIP**

FREQUENCY 27 MHz
IMPEDANCE 50 Ohm
S.W.R. 1.1 AT CENTER FREQUENCY
MAX POWER 100 W P.E.P.
HEIGHT 1000 mm
WEIGHT 260 Gr.
MOUNTING HOLE \varnothing 16 mm
WHIP FIBERGLASS
CABLE RG-58U 5 m WHITE COLOR
RELATIVE GAIN 3.5 dB
BASE TYPE SO-239

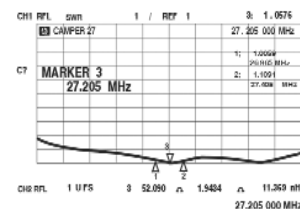

Art. 46000070

COLIBRI' 27**100 W P.E.P.****88 CM****FIBERGLASS WHIP**

FREQUENCY 27 MHz
IMPEDANCE 50 Ohm
S.W.R. ≤ 1.1 AT CENTER FREQ.
MAX POWER 100 W P.E.P.
HEIGHT 880 mm
WEIGHT 300 Gr.
MOUNTING HOLE \varnothing 8 mm
WHIP FIBERGLASS
CABLE RG-58U 5 m
RELATIVE GAIN 3 dB
BASE NOT SHORTED TO GROUND

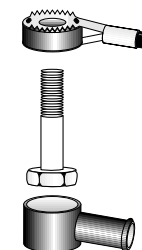
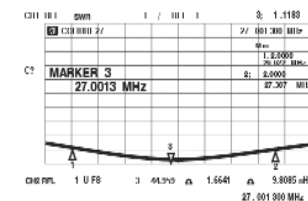

Art. 46000065

PLC 600 L PL

600 W P.E.P.

125 CM

INOX STEEL WHIP

FREQUENCY 27 MHz
IMPEDANCE 50 Ohm
S.W.R. ≤ 1.1 AT CENTER FREQ.
MAX POWER 600 W P.E.P.
HEIGHT 1250 mm
WEIGHT 700 Gr.
MOUNTING HOLE Ø 16 mm
WHIP 17.7 PH INOX STEEL
RELATIVE GAIN 4 dB
BASE SHORTED TO GROUND
BASE TYPE PL

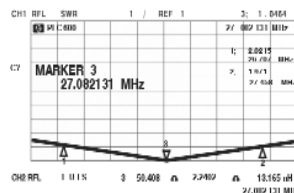

BASE TYPE PL FOR MOUNTING ON MAGNET BASE TYPE BM1 OR BM2 WITH SO-239 CONNECTOR

Art. 4600006

JURA 8

800 W P.E.P.

170 CM

INOX STEEL WHIP

FREQUENCY 27 MHz
IMPEDANCE 50 Ohm
S.W.R. ≤ 1.1 AT CENTER FREQ.
MAX POWER 800 W P.E.P.
HEIGHT 1700 mm
WEIGHT 700 Gr.
MOUNTING HOLE Ø 10 mm
WHIP 17.7 PH INOX STEEL
CABLE RG-58U 5 m
RELATIVE GAIN 4.5 dB
BASE SHORTED TO GROUND

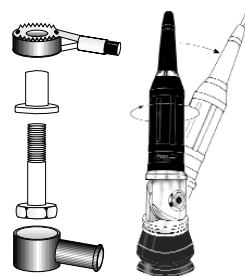
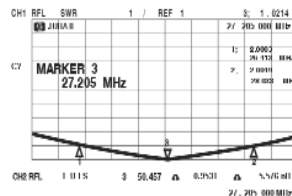

Art. 46000050

JURA 6L

600 W P.E.P.

130 CM

INOX STEEL WHIP

FREQUENCY 27 MHz
IMPEDANCE 50 Ohm
S.W.R. ≤ 1.1 AT CENTER FREQ.
MAX POWER 600 W P.E.P.
HEIGHT 1300 mm
WEIGHT 700 Gr.
MOUNTING HOLE Ø 10 mm
WHIP 17.7 PH INOX STEEL
CABLE RG-58U 5 m
RELATIVE GAIN 4 dB
BASE SHORTED TO GROUND

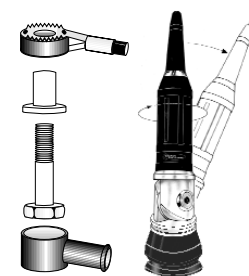
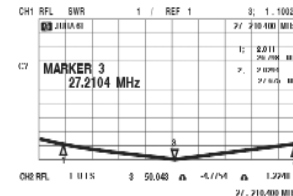

Art. 46000060

JURA 6S

600 W P.E.P.

115 CM

INOX STEEL WHIP

FREQUENCY 27 MHz
IMPEDANCE 50 Ohm
S.W.R. ≤ 1.1 AT CENTER FREQ.
MAX POWER 600 W P.E.P.
HEIGHT 1150 mm
WEIGHT 700 Gr.
MOUNTING HOLE Ø 10 mm
WHIP 17.7 PH INOX STEEL
CABLE RG-58 5U m
RELATIVE GAIN 4 dB
BASE SHORTED TO GROUND

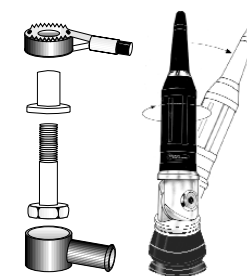
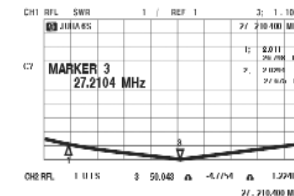

Art. 46000055

JURA 4L

400 W P.E.P.

90 CM

INOX STEEL WHIP

FREQUENCY 27 MHz

IMPEDANCE 50 Ohm

S.W.R. ≤ 1.1 AT CENTER FREQ.

MAX POWER 400 W P.E.P.

HEIGHT 900 mm

WEIGHT 600 Gr.

MOUNTING HOLE \varnothing 10 mm

WHIP 17.7 PH INOX STEEL

CABLE RG-58U 5 m

RELATIVE GAIN 4 dB

BASE SHORTED TO GROUND

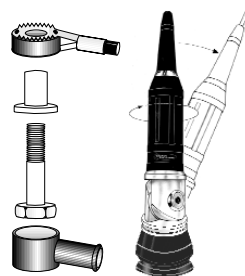
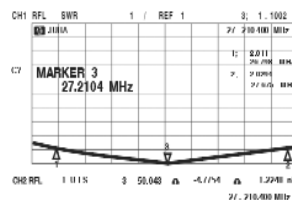

Art. 4600063

JURA 4S

400 W P.E.P.

80 CM

INOX STEEL WHIP

FREQUENCY 27 MHz

IMPEDANCE 50 Ohm

S.W.R. ≤ 1.1 AT CENTER FREQ.

MAX POWER 400 W P.E.P.

HEIGHT 800 mm

WEIGHT 700 Gr.

MOUNTING HOLE \varnothing 10 mm

WHIP 17.7 PH INOX STEEL

CABLE RG-58U 5 m

RELATIVE GAIN 4 dB

BASE SHORTED TO GROUND

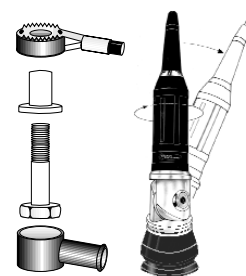
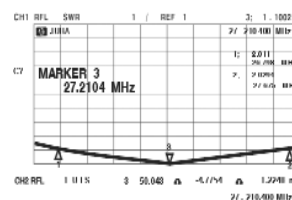

Art. 4600062

K2 110 S

200 W P.E.P.

115 CM

INOX STEEL WHIP

FREQUENCY 27 MHz

IMPEDANCE 50 Ohm

S.W.R. ≤ 1.1 AT CENTER FREQ.

MAX POWER 200 W P.E.P.

HEIGHT 1150 mm

WEIGHT 500 Gr.

MOUNTING HOLE \varnothing 10 mm

WHIP 17.7 PH INOX STEEL

CABLE RG-58U 5 m

RELATIVE GAIN 3.5 dB

BASE SHORTED TO GROUND

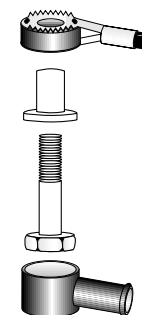
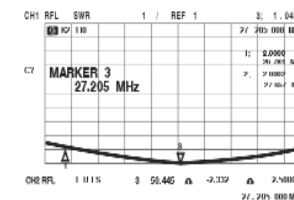

Art. 4600040

MANTOVA TURBO

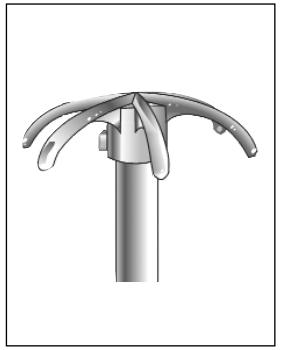

DETAIL OF THE WHIP TOP

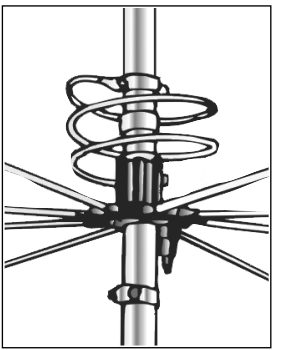

DETAIL OF THE BASE



2000 W P.E.P.
700 CM

ANTICORODAL ALUMINUM

- TYPE** 5/8 λ
- FREQUENCY** 26-28 MHz
- IMPEDANCE** 50 Ohm
- S.W.R.** 1.1
- MAX POWER** 2000 W P.E.P.
- HEIGHT** 7 m
- WEIGHT** 4.5 Kg.
- WHIP TUBES** ANTICORODAL ALUMINUM
mm x Ø 45x2 / 35x1.5 / 21x1.5 / 14x1 / 10x1
- RADIALS** 8 ALUMINUM RADIALS Ø mm 10 x 150
- RELATIVE GAIN** 8 dB
- CONNECTOR** SO-239 WITH WATERPROOF PLASTIC PROTECTION
- BASE** TUNABLE AND SHORTED TO GROUND
- MOUNTING TUBE** Ø mm 41 MAX.

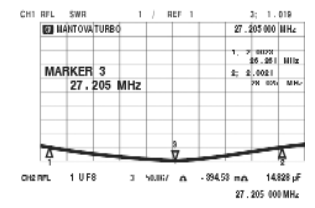

Art. 46000085

GP VR 6 M

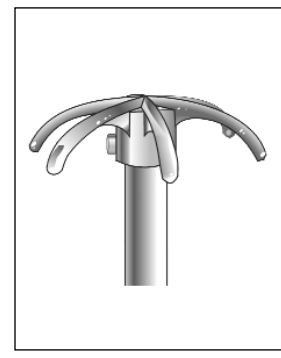

DETAIL OF THE WHIP TOP

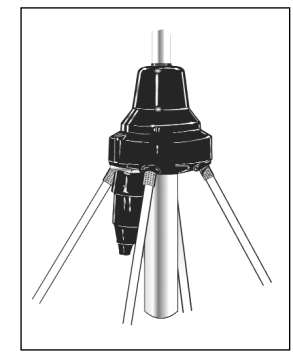

DETAIL OF THE BASE

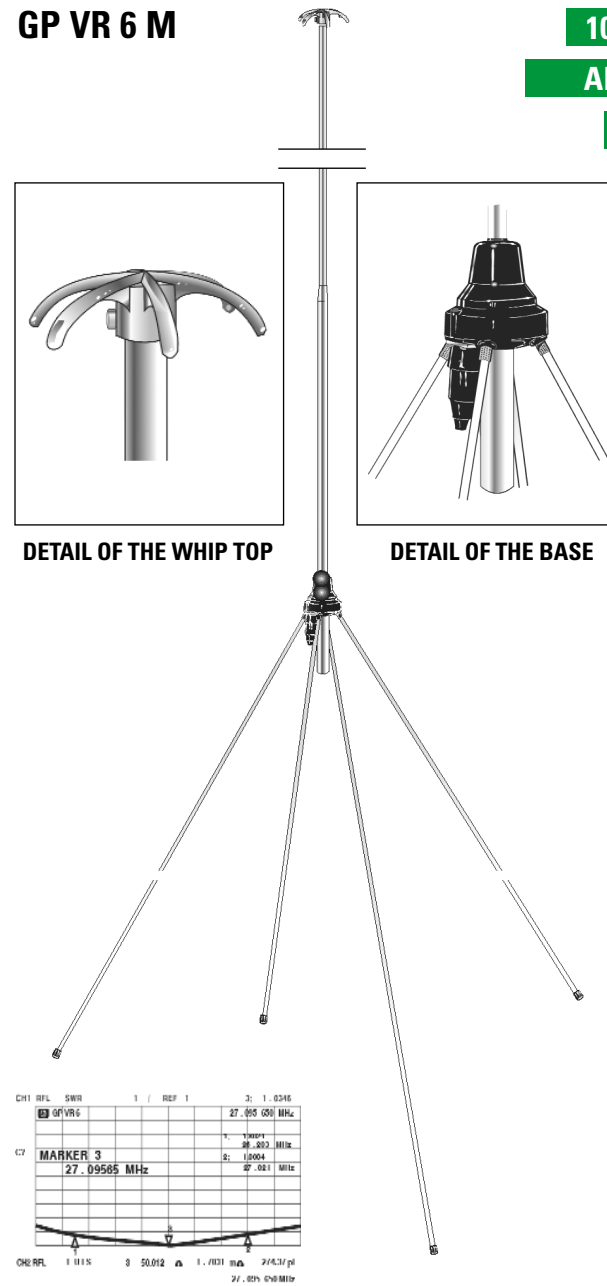

1000 W P.E.P. **440 CM**

ANTICORODAL ALUMINUM

FIBERGLASS RADIALS

- TYPE** 1/4 λ
- FREQUENCY** 27 MHz
- IMPEDANCE** 50 Ohm
- S.W.R.** ≤ 1.1
- MAX POWER** 1000 W P.E.P.
- HEIGHT** 4.40 m
- WEIGHT** 1 Kg.
- WHIP** ANTICORODAL ALUMINUM
Ø mm 14/12/10/8 STEPTABLE DOWN IN 2 PARTS
- RADIALS** 4 FIBERGLASS RADIALS
WITH COILED CONDUCTOR
- RELATIVE GAIN** 5 dB
- CONNECTOR** SO-239 WITH PLASTIC PROTECTION
- BASE** THERMOSETTING MATERIAL
COMPLETELY WATERPROOF
- WIND RESISTANCE** 150 Km/h
- MOUNTING TUBE** Ø mm 25

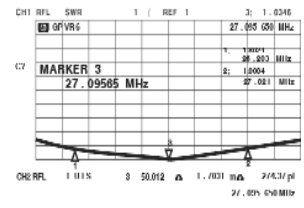

GP VR 6 GOLD

- SAME SPECIFICATIONS AS MODEL GP VR 6M, BUT WITH ANODIZED TREATED WHIP, IMMERSION COLORED, WITH GOLD INORGANIC COLOR.
- THESE TREATMENTS ASSURE AN EXCELLENT RESISTANCE IN THE LONG TIME AGAINST AGGRESSIVE ATMOSPHERICS (SALTNESS, SMOG, BAD WEATHER)

Art. 46000095 (VR 6 M)
Art. 46000090 (VR 6 GOLD)

CITY

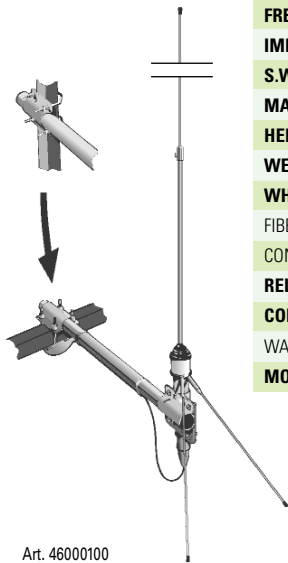
400 W P.E.P. / 280 CM
ALUMINUM & FIBERGLASS

FREQUENCY 27 MHz
IMPEDANCE 50 Ohm
S.W.R. ≤ 1.1 AT CENTER FREQ.
MAX POWER 400 W P.E.P.
HEIGHT 2.80 m
WEIGHT 1.4 Kg.
WHIP / RADIALS ALUMINUM & FIBERGLASS WITH COILED CONDUCTORS
RELATIVE GAIN 3 dB
CONNECTOR SO-239 WITH WATERPROOF PLASTIC PROTECTION
MOUNTING MAST HORIZ. OR VERT.

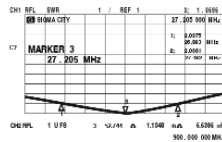

Art. 46000100

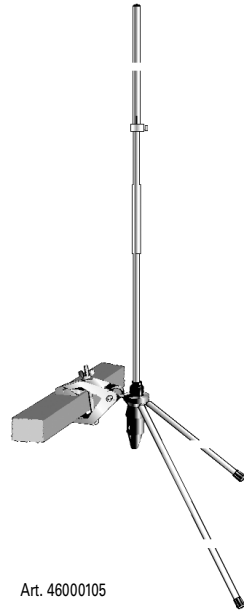
UNIVERSAL
2a SERIE
200 W P.E.P.
200 CM
ALUMINUM WHIP

FREQUENCY 27-28 MHz
IMPEDANCE 50 Ohm
S.W.R. 1.2 AT CENTER FREQ.
MAX POWER 200 W P.E.P.
HEIGHT 2 m
WEIGHT 600 Gr.
WHIP ALUMINUM
RADIALS FIBERGLASS
RELATIVE GAIN 3 dB
CONNECTOR SO-239 WITH WATERPROOF PLASTIC PROTECTION
MOUNTING MAST HORIZ. OR VERT.

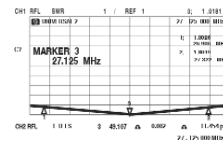

Art. 46000105

GP MINI-R

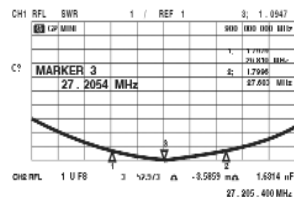
400 W P.E.P. / 220 CM
ALUMINUM & FIBERGLASS

Art. 46000110

FREQUENCY 27 MHz
IMPEDANCE 50 Ohm
S.W.R. 1.1 AT CENTER FREQUENCY
MAX POWER 400 W P.E.P.
HEIGHT 2.20 m **WEIGHT** 700 Gr.
WHIP / RADIALS ALUMINUM & FIBERGLASS WITH COILED CONDUCTORS
BASE THERMOSETTING MATERIAL COMPLETELY WATERPROOF
RELATIVE GAIN 3 dB
CONNECTOR SO-239 WITH WATERPROOF PLASTIC PROTECTION
MOUNTING TUBE \varnothing 25 mm MAX

4-ELEMENT BEAM

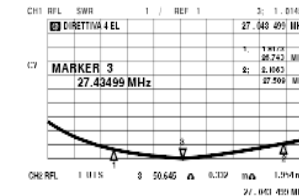
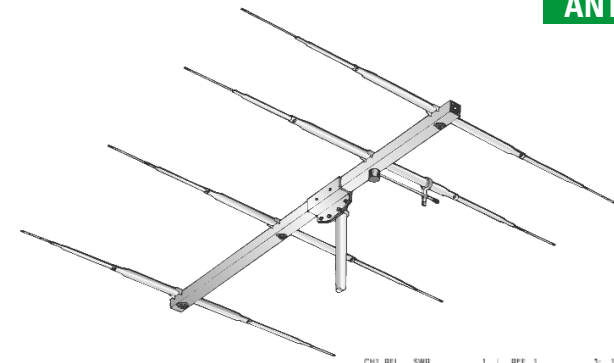
1000 W P.E.P. **4 ELEMENTS**
ANTICORODAL ALUMINUM

Art. 46000115

FREQ. 27 MHz **IMPED.** 50 Ohm
S.W.R. ≤ 1.1 AT CENTER FREQ.
MAX POWER 1000 W P.E.P.
POLARISATION VERT. OR HORIZ.
RADIATOR ADJUSTABLE WITH RANGE MATCH
ELEMENTS 4
BOOM DIMENS. 30 x 30 x 4000 mm
REFLECTOR 5.70 m
1° DIRECTOR 4.80 m
MOUNTING TUBE \varnothing 24 mm MIN. / \varnothing 2" MAX
MATERIAL ANTICORODAL ALUMINUM
F/B RATIO 30 dB **WEIGHT** 7 Kg.
RELATIVE GAIN 11 dB
CONNECTOR SO-239

3-ELEMENT BEAM

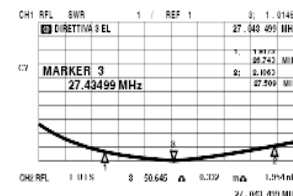
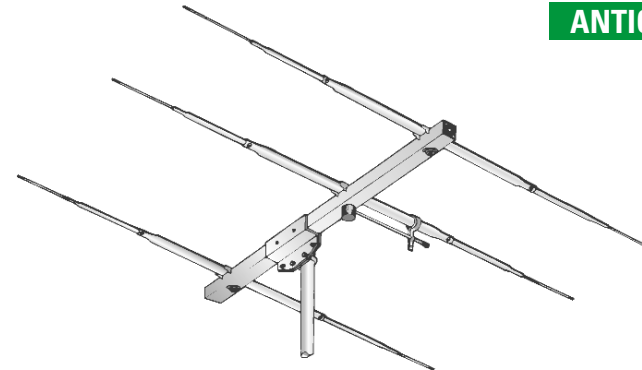
1000 W P.E.P. **3 ELEMENTS**
ANTICORODAL ALUMINUM

Art. 46000120

FREQ. 27 MHz **IMPED.** 50 Ohm
S.W.R. ≤ 1.1 AT CENTER FREQ.
MAX POWER 1000 W P.E.P.
POLARISATION VERT. OR HORIZ.
RADIATOR ADJUSTABLE WITH RANGE MATCH
ELEMENTS 3
BOOM DIMENS. 30 x 30 x 2850 mm
REFLECTOR 5.70 m
1° DIRECTOR 4.80 m
WEIGHT 4 Kg.
MOUNTING TUBE \varnothing 2" MAX
MATERIAL ANTICORODAL ALUMINUM
RELATIVE GAIN 8 dB
CONNECTOR SO-239

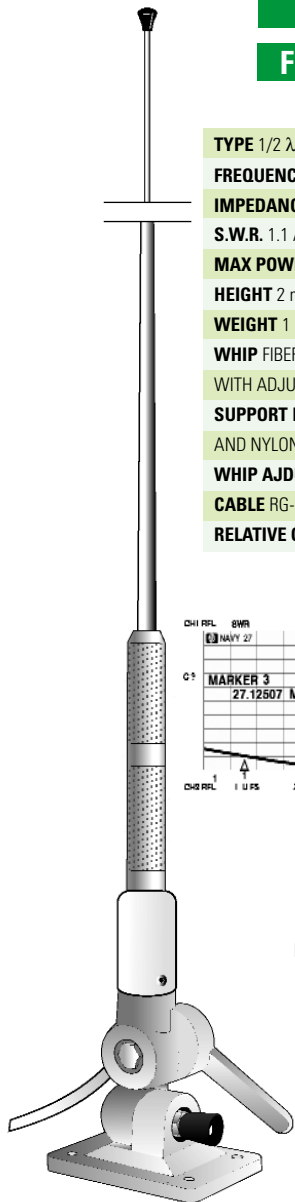
NAVY 27
150 W P.E.P.
200 CM
FIBERGLASS

TYPE 1/2 λ
FREQUENCY 27 MHz
IMPEDANCE 50 Ohm
S.W.R. 1.1 AT CENTER FREQUENCY
MAX POWER 150 W P.E.P.
HEIGHT 2 m
WEIGHT 1 Kg.
WHIP FIBERGLASS 1.80 m HEIGHT
 WITH ADJUSTABLE LOAD COIL
SUPPORT BASE FIBERGLASS
 AND NYLON 66 FU WITH JOINT
WHIP AJDUST FOLDABLE 4 AXES
CABLE RG-58U 5 m WHITE COLOR
RELATIVE GAIN 3.5 dB

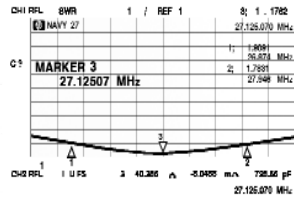

5 MT RG-58U
WHITE COLOR CABLE
INCLUDED AND
DIRECTLY CONNECTED
TO THE ANTENNA

Art. 46000130

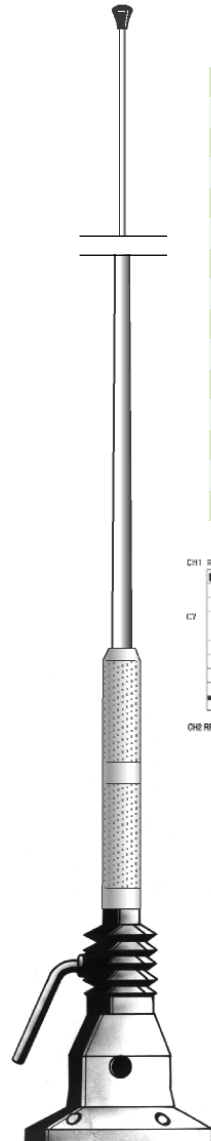
NAUTICA 50
NAUTICA 200
50 W / 200 W
195 CM
FIBERGLASS

TYPE 1/4 λ
FREQUENCY 27 MHz
IMPEDANCE 50 Ohm
S.W.R. 1.1 AT CENTER FREQUENCY
MAX POWER
 50 W (mod. **NAUTICA 50**)
 200 W (mod. **NAUTICA 200**)
HEIGHT 1.95 m
WEIGHT 1 Kg.
WHIP FIBERGLASS 1.80 m HEIGHT
 WITH ADJUSTABLE LOAD COIL
 AND DOUBLE JOINT
WHIP AJDUST 180° MAX.
CABLE RG-58U 5 m WHITE COLOR
RELATIVE GAIN 3.5 dB

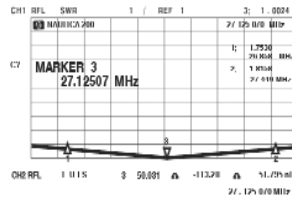

5 MT RG-58U
WHITE COLOR CABLE
INCLUDED AND
DIRECTLY CONNECTED
TO THE ANTENNA

 Art. 46000140 (NAUTICA 50)
 Art. 46000135 (NAUTICA 200)

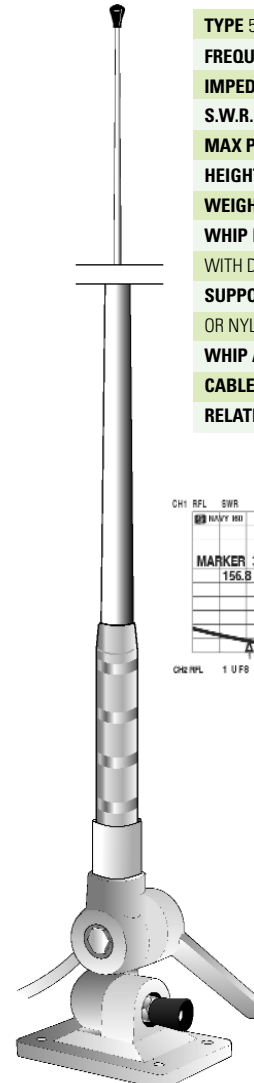
NAVY 160
100 W
165 CM
FIBERGLASS

TYPE 5/8 λ
FREQUENCY 150-165 MHz
IMPEDANCE 50 Ohm
S.W.R. 1.2 AT CENTER FREQUENCY
MAX POWER 100 W
HEIGHT 1.65 m
WEIGHT 0.8 Kg.
WHIP FIBERGLASS 1.40 m HEIGHT
 WITH DOUBLE SCREWING CONTACT
SUPPORT BASE FIBERGLASS
 OR NYLON 66 FU WITH JOINT
WHIP AJDUST FOLDABLE 4 AXES
CABLE RG-58U 5 m WHITE COLOR
RELATIVE GAIN 3.5 dB

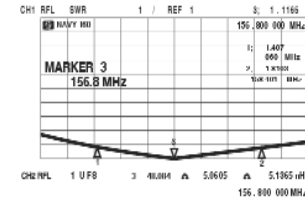

5 MT RG-58U
WHITE COLOR CABLE
INCLUDED AND
DIRECTLY CONNECTED
TO THE ANTENNA

Art. 46000145

MARINOX
100 W
115 CM
INOX STEEL WHIP

TYPE 1/4 λ
FREQUENCY 156-162 MHz
IMPEDANCE 50 Ohm
S.W.R. 1.2 AT CENTER FREQUENCY
MAX POWER 100 W
HEIGHT 1.15 m
WEIGHT 300 Gr.
WHIP INOX STEEL AISI 301
CONNECTOR SO-239
MOUNTING L BRACKET INCLUDED
RELATIVE GAIN 3 dB

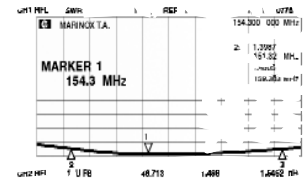

Art. 46000150

COLIBRI' 144 1/4

100 W

55 CM

INOX STEEL WHIP

TYPE 1/4 λ

FREQUENCY 143-175 MHz

IMPEDANCE 50 Ohm

S.W.R. 1.2 AT CENTER FREQUENCY

MAX POWER 100 W

HEIGHT 550 mm

WEIGHT 300 Gr.

MOUNTING HOLE \varnothing 8 mm

WHIP 17.7 PH INOX STEEL

CABLE RG-58 5 m

RELATIVE GAIN 2 dB

BASE NOT SHORTED TO GROUND

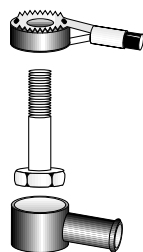
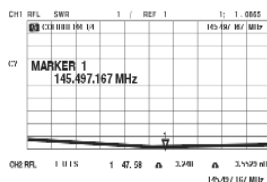

Art. 46000195

COLIBRI' AIR

100 W

60 CM

INOX STEEL WHIP

FREQUENCY 118-136 MHz

IMPEDANCE 50 Ohm

S.W.R. 1.2 AT CENTER FREQUENCY

MAX POWER 100 W

HEIGHT 600 mm

WEIGHT 300 Gr.

MOUNTING HOLE \varnothing 8 mm

WHIP 17.7 PH INOX STEEL

CABLE RG-58 5 m

RELATIVE GAIN 2 dB

BASE NOT SHORTED TO GROUND

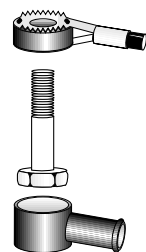

Art. 46000200

DX-144 5/8

100 W

137 CM

FIBERGLASS WHIP

TYPE 5/8 λ

FREQUENCY 144-175 MHz

IMPEDANCE 50 Ohm

S.W.R. 1.2 AT CENTER FREQUENCY

MAX POWER 100 W

HEIGHT 1.37 m

WEIGHT 600 Gr.

MOUNTING HOLE \varnothing 8 mm

WHIP FIBERGLASS BLACK COLOR

CABLE RG-58 5 m

RELATIVE GAIN 3 dB

BASE NOT SHORTED TO GROUND

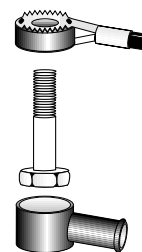
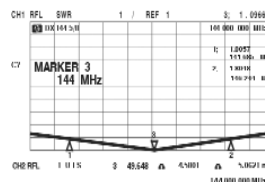
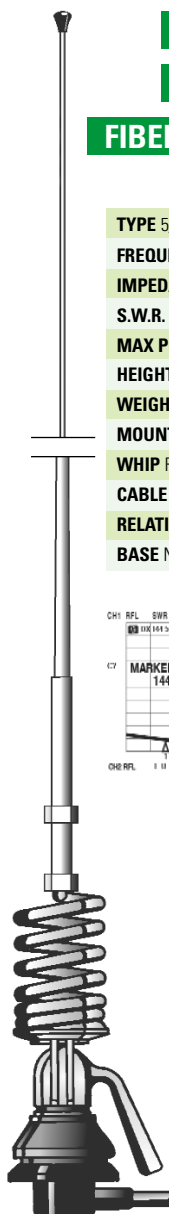

Art. 46000185

COLIBRI' 430

200 W

60 CM

INOX STEEL WHIP

TYPE 1/2 λ

FREQUENCY 400-450 MHz

IMPEDANCE 50 Ohm

S.W.R. 1.3

MAX POWER 200 W

HEIGHT 600 mm

WEIGHT 300 Gr.

MOUNTING HOLE \varnothing 8 mm

WHIP INOX STEEL

CABLE RG-58 5 m

RELATIVE GAIN 4 dB

BASE NOT SHORTED TO GROUND

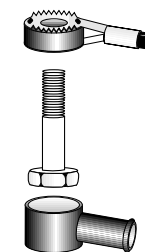

Art. 46000505

COLIBRI' BIBANDA

100 W

50 CM

INOX STEEL WHIP

TYPE 1/4 λ VHF - 1/2 λ UHF

FREQUENCY 145-432 MHz

IMPEDANCE 50 Ohm

S.W.R. 1.2 AT FREQ. REQ.

MAX POWER 100 W

HEIGHT 500 mm

WEIGHT 300 Gr.

MOUNTING HOLE \varnothing 8 mm

WHIP INOX STEEL

CABLE RG-58 5 m

RELATIVE GAIN 2 dB

BASE NOT SHORTED TO GROUND

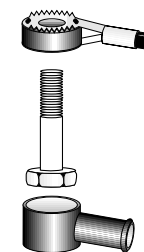
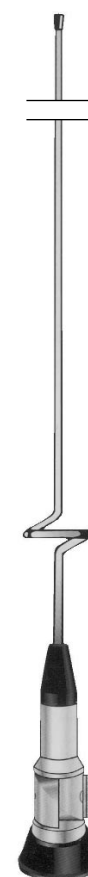

Art. 46000500

GP FM/R **140 CM**
88-108 MHz RX ANTENNA
ANTICORODAL ALUMINUM

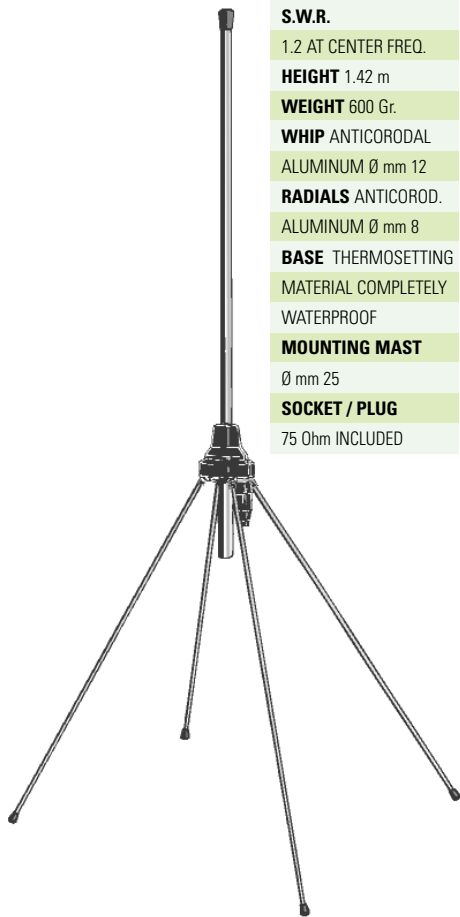

TYPE 1/4 λ
FREQ. 88-108 MHz
IMPEDANCE 75 Ohm
S.W.R.
1.2 AT CENTER FREQ.
HEIGHT 1.42 m
WEIGHT 600 Gr.
WHIP ANTICORODAL
ALUMINUM Ø mm 12
RADIALS ANTICOROD.
ALUMINUM Ø mm 8
BASE THERMOSETTING
MATERIAL COMPLETELY
WATERPROOF
MOUNTING MAST
Ø mm 25
SOCKET / PLUG
75 Ohm INCLUDED

Art. 46000235

GP AIR **200 W / 100 CM**
ANTICORODAL ALUMINUM

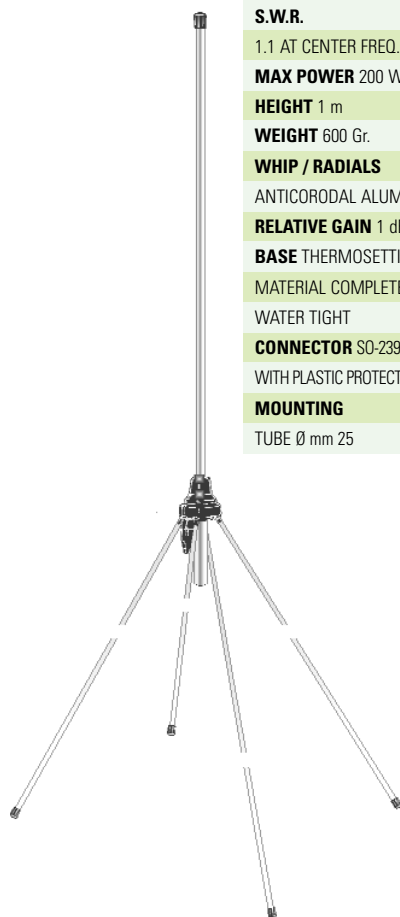

TYPE 1/4 λ
FREQ. 118-136 MHz
IMPEDANCE 50 Ohm
S.W.R.
1.1 AT CENTER FREQ.
MAX POWER 200 W
HEIGHT 1 m
WEIGHT 600 Gr.
WHIP / RADIALS
ANTICORODAL ALUM.
RELATIVE GAIN 1 dB
BASE THERMOSETTING
MATERIAL COMPLETELY
WATER TIGHT
CONNECTOR SO-239
WITH PLASTIC PROTECTION
MOUNTING
TUBE Ø mm 25

Art. 46000240

GP 145 5/8 **200 W / 140 CM**
ANTICORODAL ALUMINUM

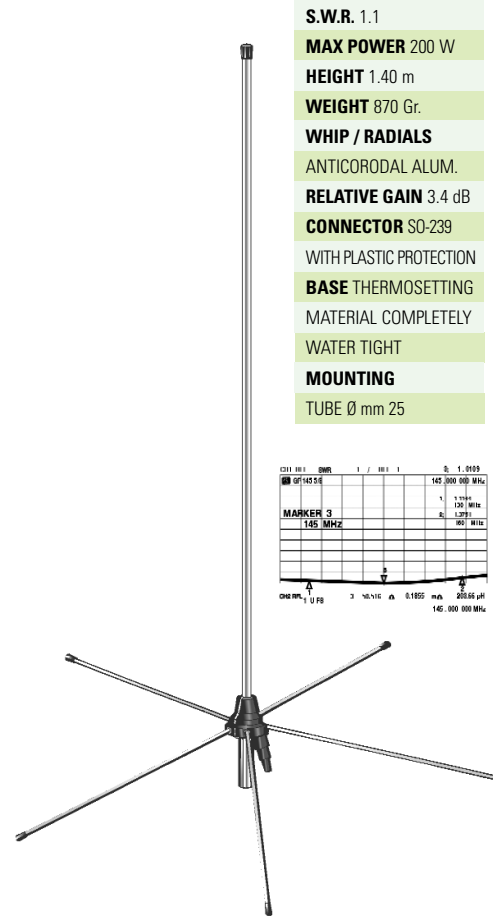

TYPE 5/8 λ
FREQ. 140-150 MHz
IMPEDANCE 50 Ohm
S.W.R. 1.1
MAX POWER 200 W
HEIGHT 1.40 m
WEIGHT 870 Gr.
WHIP / RADIALS
ANTICORODAL ALUM.
RELATIVE GAIN 3.4 dB
CONNECTOR SO-239
WITH PLASTIC PROTECTION
BASE THERMOSETTING
MATERIAL COMPLETELY
WATER TIGHT
MOUNTING
TUBE Ø mm 25

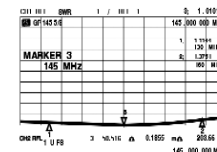

Art. 46000261

COLLINEARE 160 **410 CM**
COLLINEARE 145 **200W P.E.P.**
ANTICORODAL ALUMINUM

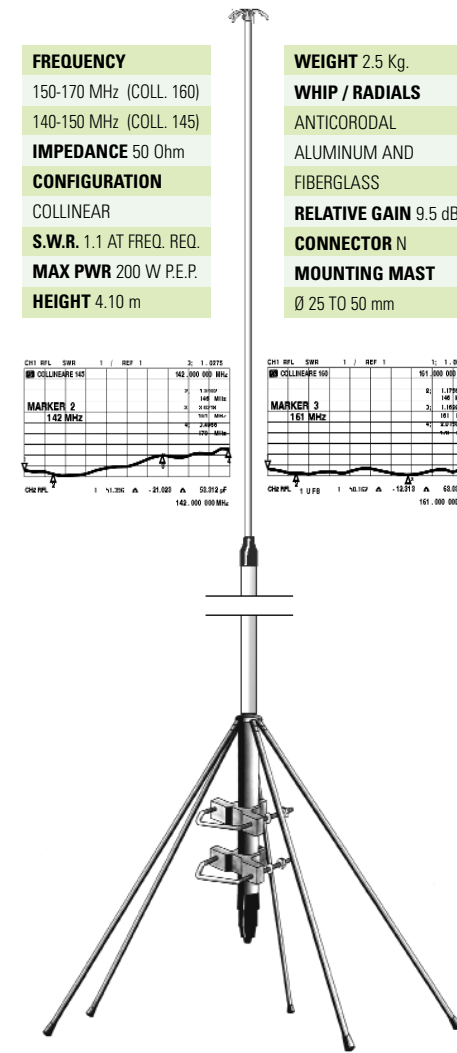

FREQUENCY
150-170 MHz (COLL. 160)
140-150 MHz (COLL. 145)
IMPEDANCE 50 Ohm
CONFIGURATION
COLLINEAR
S.W.R. 1.1 AT FREQ. REQ.
MAX PWR 200 W P.E.P.
HEIGHT 4.10 m

WEIGHT 2.5 Kg.
WHIP / RADIALS
ANTICORODAL
ALUMINUM AND
FIBERGLASS
RELATIVE GAIN 9.5 dB
CONNECTOR N
MOUNTING MAST
Ø 25 TO 50 mm

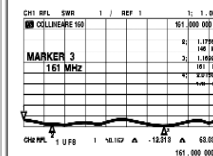
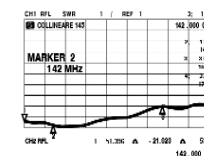

Art. 46000246 (COLLINEARE 160)
 Art. 46000245 (COLLINEARE 145)

3-ELEMENT BEAM 145 3-ELEMENT BEAM 160

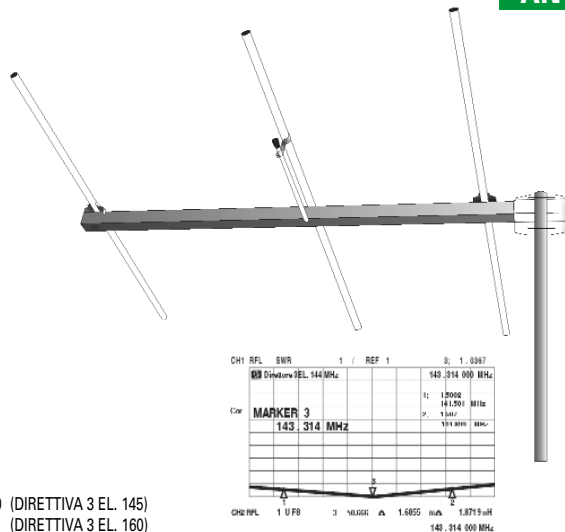

Art. 46000250 (DIRETTIVA 3 EL. 145)
 Art. 46000251 (DIRETTIVA 3 EL. 160)

200 W **3 ELEMENTS**
ANTICORODAL ALUMINUM

FREQUENCY
 143-147 MHz (DIRETTIVA 3 EL. 145)
 157-161 MHz (DIRETTIVA 3 EL. 160)
IMPEDANCE 50 Ohm
 ADJUSTABLE WITH RANGE MATCH
S.W.R. 1.1 AT CENTER FREQUENCY
MAX POWER 200 W
POLARISATION VERT. OR HORIZ.
ELEMENTS 3
BOOM DIMENS. 30 x 30 x 1000 mm
TUBES mm 20 x 1 AND 14 x 1
WEIGHT 1.4 Kg.
MATERIAL ANTICORODAL ALUMINUM
F/B RATIO 17 dB
RELATIVE GAIN 7 dB
CONNECTOR N
 WITH PLASTIC PROTECTION

9-ELEMENT BEAM

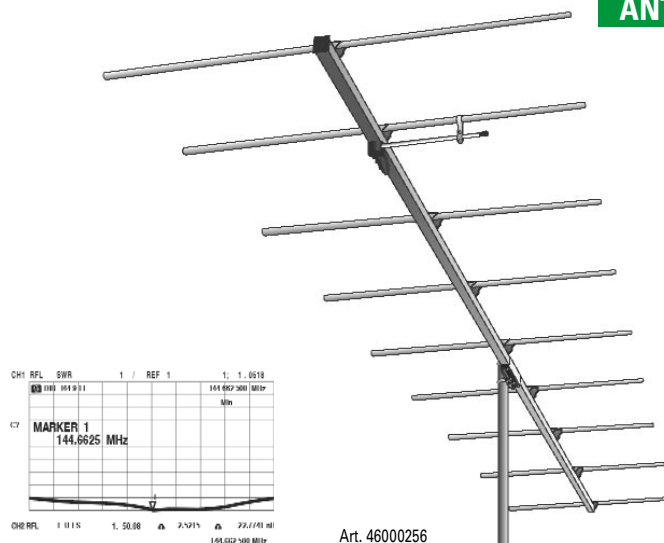

Art. 46000256

200 W **9 ELEMENTS**
ANTICORODAL ALUMINUM

FREQUENCY 143-147 MHz
IMPEDANCE 50 Ohm
 ADJUSTABLE WITH RANGE MATCH
S.W.R. 1.1 AT CENTER FREQUENCY
MAX POWER 200 W
POLARISATION VERT. OR HORIZ.
ELEMENTS 9
BOOM DIMENS. 30 x 30 x 4000 mm
TUBES mm 20 x 1 AND 14 x 1
WEIGHT 4.1 Kg.
MATERIAL ANTICORODAL ALUMINUM
F/B RATIO 35 dB
RELATIVE GAIN 14 dB
CONNECTOR N
 WITH PLASTIC PROTECTION

UNIVERSAL 144

100 W / 80 CM

ANTICORODAL ALUMINUM



Art. 46000530

FREQ. 144-146 MHz
IMPEDANCE 50 Ohm
S.W.R.
 ≤ 1.2 AT CENTER FREQ.
MAX POWER 100 W
HEIGHT 80 cm
WEIGHT 300 Gr.
WHIP / RADIALS
 ALUMINUM
RELATIVE GAIN 2 dB
CONNECTOR SO-239
 WITH PLASTIC PROTECTION
MOUNTING MAST
 HORIZ. OR VERT.

PLC 43

600 W

130 CM

INOX STEEL WHIP

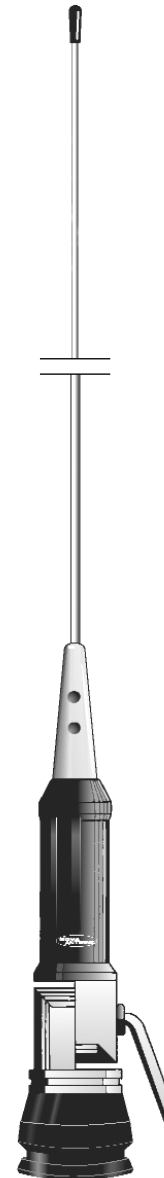

FREQUENCY 43 MHz
IMPEDANCE 50 Ohm
S.W.R. 1.1 AT CENTER FREQUENCY
MAX POWER 600 W
HEIGHT 1300 mm
WEIGHT 700 Gr.
MOUNTING HOLE Ø 8 mm
WHIP INOX STEEL
CABLE RG-58U 5 m
RELATIVE GAIN 2 dB
BASE SHORTED TO GROUND

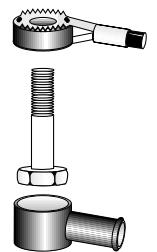
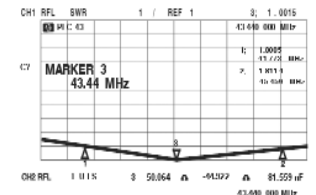

Art. 46000210

COLIBRI' 43

100 W

55 CM

FIBERGLASS WHIP



- TYPE 1/4 λ
- FREQUENCY 43 MHz
- IMPEDANCE 50 Ohm
- S.W.R. 1.1 AT CENTER FREQUENCY
- MAX POWER 100 W
- HEIGHT 550 mm
- WEIGHT 250 Gr.
- MOUNTING HOLE Ø 8 mm
- WHIP FIBERGLASS
- CABLE RG-58U 5 m
- RELATIVE GAIN 1 dB
- BASE NOT SHORTED TO GROUND

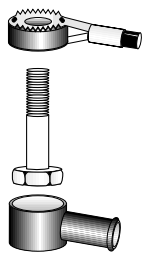
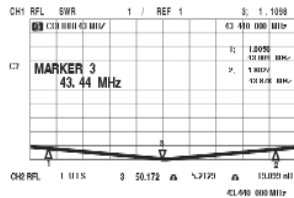

Art. 46000215

BALCONY 43

400 W

185 CM

FIBERGLASS

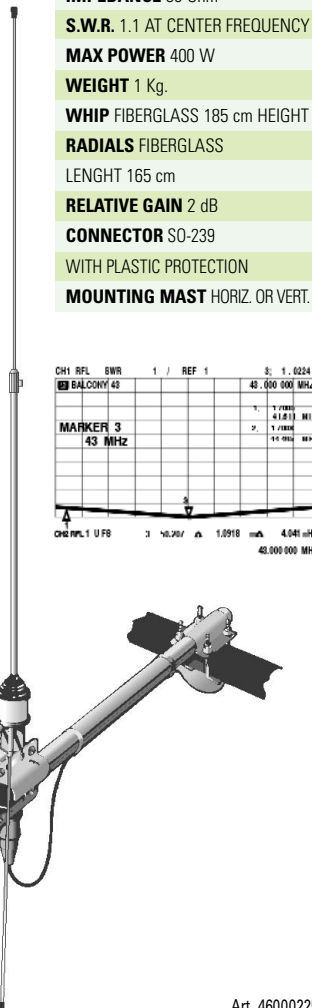

- FREQUENCY 43 MHz
- IMPEDANCE 50 Ohm
- S.W.R. 1.1 AT CENTER FREQUENCY
- MAX POWER 400 W
- WEIGHT 1 Kg.
- WHIP FIBERGLASS 185 cm HEIGHT
- RADIALS FIBERGLASS
- LENGHT 165 cm
- RELATIVE GAIN 2 dB
- CONNECTOR SO-239
- WITH PLASTIC PROTECTION
- MOUNTING MAST HORIZ. OR VERT.

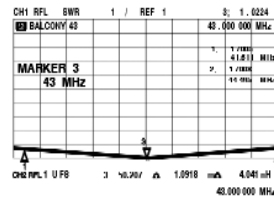

Art. 46000225

TURBO 43

2000 W

430 CM

ANTICORODAL ALUMINUM

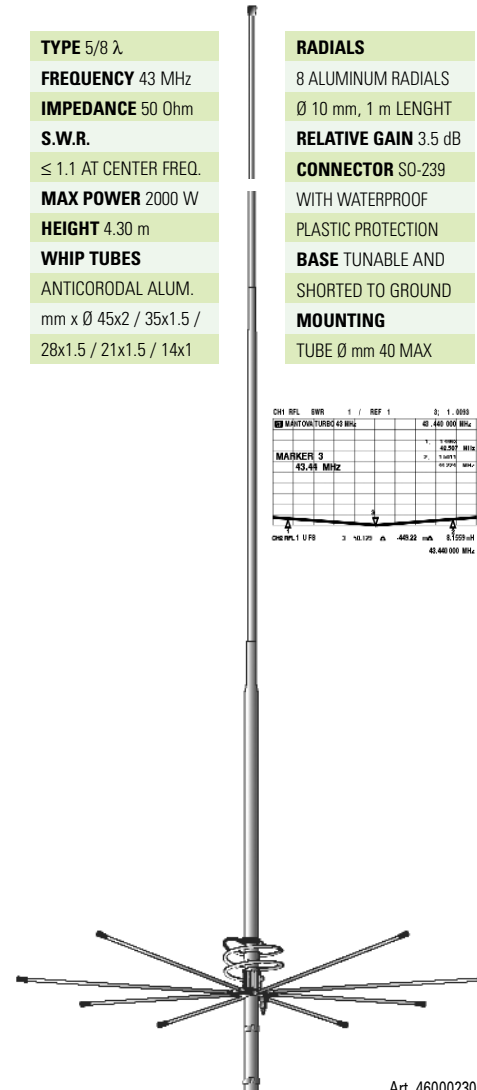

- TYPE 5/8 λ
- FREQUENCY 43 MHz
- IMPEDANCE 50 Ohm
- S.W.R. ≤ 1.1 AT CENTER FREQ.
- MAX POWER 2000 W
- HEIGHT 4.30 m
- WHIP TUBES ANTICORODAL ALUM.
- mm x Ø 45x2 / 35x1.5 / 28x1.5 / 21x1.5 / 14x1
- RADIALS 8 ALUMINUM RADIALS
- Ø 10 mm, 1 m LENGHT
- RELATIVE GAIN 3.5 dB
- CONNECTOR SO-239
- WITH WATERPROOF PLASTIC PROTECTION
- BASE TUNABLE AND SHORTED TO GROUND
- MOUNTING TUBE Ø mm 40 MAX

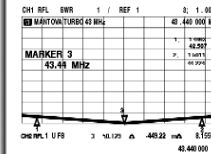

Art. 46000230

GP 43

400 W

300 CM

ANTICORODAL ALUMINUM

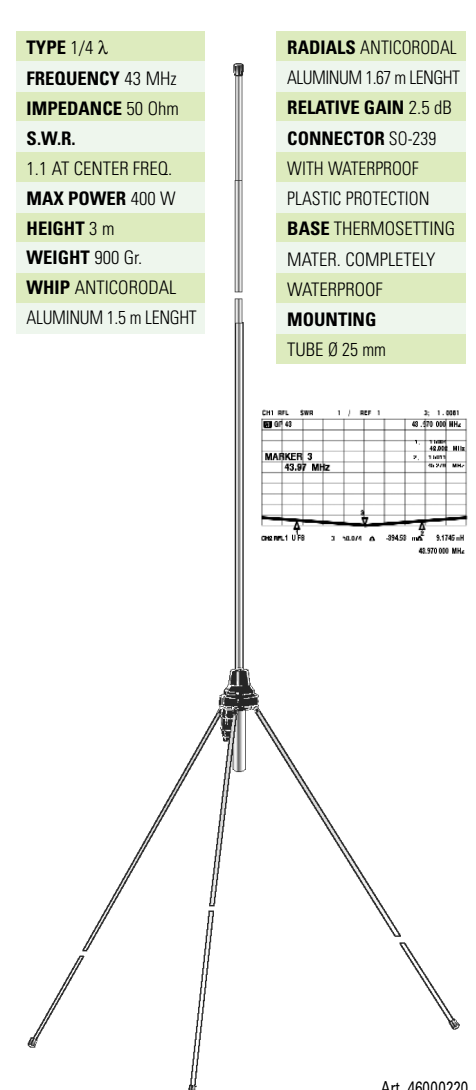

- TYPE 1/4 λ
- FREQUENCY 43 MHz
- IMPEDANCE 50 Ohm
- S.W.R. 1.1 AT CENTER FREQ.
- MAX POWER 400 W
- HEIGHT 3 m
- WEIGHT 900 Gr.
- WHIP ANTICORODAL ALUMINUM 1.5 m LENGHT
- RADIALS ANTICORODAL ALUMINUM 1.67 m LENGHT
- RELATIVE GAIN 2.5 dB
- CONNECTOR SO-239
- WITH WATERPROOF PLASTIC PROTECTION
- BASE THERMOSETTING MATER. COMPLETELY WATERPROOF
- MOUNTING TUBE Ø 25 mm

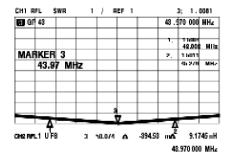

Art. 46000220

BM1
 Ø 120 mm

**UNIVERSAL MOUNT
MAGNET BASE**

UNIVERSAL MOUNT
MAGNET BASE
Ø 120 mm
ANTENNA HOLE
Ø mm 10
WEIGHT 950 Gr.
RUBBER
PROTECTIVE
GASKET

Art. 46000270

BM1 PL
 Ø 120 mm

**SO-239 MOUNT
MAGNET BASE**

SO-239 MOUNT
MAGNET BASE
4.5 mt RG-58U CABLE
WITH PL-259
DIAMETER mm 120
WEIGHT 950 Gr.
RUBBER
PROTECTIVE
GASKET

Art. 46000275

BM2
 Ø 86 mm

**UNIVERSAL MOUNT
MAGNET BASE**

UNIVERSAL MOUNT
MAGNET BASE
Ø 86 mm
ANTENNA HOLE
Ø mm 10
WEIGHT 400 Gr.
RUBBER
PROTECTIVE
GASKET

Art. 46000280

BM2 PL
 Ø 86 mm

**SO-239 MOUNT
MAGNET BASE**

SO-239 MOUNT
MAGNET BASE
4.5 mt RG-58U CABLE
WITH PL-259
DIAMETER mm 86
WEIGHT 400 Gr.
RUBBER
PROTECTIVE
GASKET

Art. 46000285

**RG-58U
CABLE 45 cm**
**PL-259
CONNECTORS**

RG-58U COAXIAL CABLE
WITH 2 x
PL-259 CONNECTORS
LENGHT 45 cm

Art. 46000310

**RG-58U
CABLE 90 cm**
**PL-259
CONNECTORS**

RG-58U COAXIAL CABLE
WITH 2 x
PL-259 CONNECTORS
LENGHT 90 cm

Art. 46000311

**CABLE
098 4.5 mt**
**RG-58U
ANTENNA CABLE**

RG-58U COAXIAL CABLE WITH STANDARD ANTENNA
CONNECTOR LENGHT 4.5 mt

Art. 46000400

UG 175
FOR RG-58U CABLE



ADAPTER
FOR RG-58U
COAXIAL CABLE
AND FOR
PL-259 CONNECTOR

Art. 46000322

**ADJUSTABLE
GUTTER MOUNT**
**GUTTER
MOUNT**

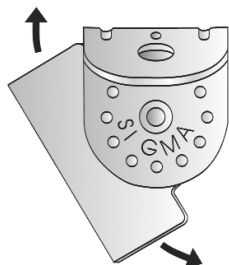

ADJUSTABLE
GUTTER MOUNT BRACKET
RANGE 45°
HOLE DIAMETER mm 10
SIZE 75 x 73 mm
INOX HARDWARE

Art. 46000290

**ADJUSTABLE
DOOR MOUNT**
DOOR MOUNT

ADJUSTABLE
DOOR MOUNT BRACKET
HOLE DIAMETER mm 10
RUBBER PROTECTIVE GASKET
FOR SIDE AND REAR DOORS,
ENGINE DOOR AND
REAR TRUNK

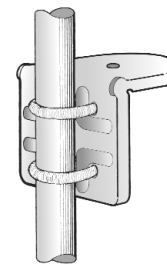
Art. 46000300

**ADJUSTABLE
MIRROR MOUNT**
**MIRROR MOUNT
FOR TRUCKS**

ADJUSTABLE MIRROR
MOUNT BRACKET
FOR TRUCKS
HOLE DIAMETER mm 10

Art. 46000305

PL 259/9
FOR RG-213 CABLE

PL-259 CONNECTOR
FOR RG-213 CABLE
TEFLON
ISOLATING MATERIAL

Art. 46000465

PL 259/R
FOR RG-58U CABLE

PL-259/R CONNECTOR
FOR RG-58U CABLE
TEFLON
ISOLATING MATERIAL

Art. 46000466

COMING SOON NEW PRODUCTS DISPLAY !

ELECTRONIC HOBBY TOOLS

SOLDERING IRONS / SOLDERING STATIONS



ATEEN
Thermo-Control Anti-Static
soldering stations



INTEK
Dual Power soldering stations



INTEK
Dual Power soldering irons



INTEK
Single Power soldering irons



INTEK
Work Bench Support and Accessories
for soldering irons

DIGITAL MULTI-METERS



HONEYTEK
Manual range
digital meters



HONEYTEK
Automatic range
digital meters



HONEYTEK
Hobby
digital meters

QUALITY TOOLS FOR KIT-BUILDING, SERVICE AND REPAIRS



GOLDTOOL
High quality soft rubber
grip and Chrome Nickel
Steel tools specifically
designed for electronics

SECURITY DEVICES

PROFESSIONAL HEAVY-DUTY ALUMINUM LED FLASHLIGHTS

SERPENT
Heavy-Duty full metal
Aluminum LED
Flashlights for
professional and security
use. Rechargeable,
complete with high
capacity battery pack
and charger



LIGHT DUTY ALUMINUM LED FLASHLIGHTS BATTERY, RECHARGEABLE AND DYNAMO POWERED

INTEK
Aluminum LED Flashlights, 1-5
LED, full metal body, rubber grip,
rechargeable and Dynamo
powered models also available



RECHARGEABLE



RECHARGEABLE / DYNAMO OPERATED



OUTDOOR LIFE PRODUCTS

FLOATING AND SENSOR MOBILE PHONES



INTEK
FLOATING AND SENSOR
MOBILE PHONES

Tri-band and Quadri-band
GSM Mobile Phones with
WATERPROOF AND
FLOATING CAPACITY,
DIGITAL COMPASS,
ALTIMETER,
THERMOMETER,
BAROMETER, LED TORCH
and more !



DIGITAL COMPASS, ALTIMETER,
AIR PRESSURE, BAROMETER,
THERMOMETER, WEATHER
FORECAST, CLOCK, DATE

INTEK
Multi-function Digital Compass
with Altimeter and several other
useful functions for hiking,
tracking, camping and outdoor life



FULL DETAILS ON THESE NICE NEW PRODUCTS ON www.intek-radios.com

NEW PRODUCT !



KT-930EE

**HIGH CAPACITY 2200mAh
Li-Ion BATTERY PACK**

**128CH / 50 CTCSS / 105 DCS
OFFSET FREQ. 0-69950 MHz**

**8 FREQUENCY STEPS (KHz)
5/6.25/10/12.5/25/37.5/50/100**

**POWER ON MESSAGE
DISPLAY**

**FREE SOFTWARE
DOWNLOAD**

**SQUELCH TAIL
ELIMINATION**

**1750 Hz REPEATER TONE
WIRE CLONE**

**AMATEUR RADIO
DUAL BAND TRANSCEIVER
144-430 MHz SW / 430-440 MHz SW
RUGGED HEAVY DUTY HANDHELD**

**144-146 MHz (136-174 MHz)
430-440 MHz (400-470 MHz)
Dual Band / Dual Freq. / Dual Display
Dual Stand-By, Wide/Narrow mode
Power On Password and much more !**

page 15

NEW PRODUCT !

PL-660

**SW (MHz)
1,7-30,0**

**FM (MHz)
88-108**

**MW (KHz)
520-1710**

**LW (KHz)
100-519**

**AIR (MHz)
118-137**



page 36



Ext. Ant., Earset, DC IN



Tuning and SSB BFO Controls

**HF AMATEUR RADIO AND GENERAL COVERAGE
SHORTWAVE RECEIVER + VHF AIR BAND
MODES : AM-FM-USB-LSB / 2000 MEMORIES**

**1711-30000 KHz / 522-1620 KHz / 100-519 KHz
88-108 MHz / 118-137 MHz (Aircraft AM)
BFO control for SSB, Auto-Scan, Auto-Tune
RF Gain (DX / Normal / Local), etc.**

INTEK®

INTEK S.R.L.
HEAD OFFICE / INTERNATIONAL SALES OFFICE
16, Via Guglielmo Marconi
20090 Segrate, Italy
Tel. : +3902 2695 0451 / +3902 2695 0377
Tel. : +3902 2187 1286
Fax : +3902 2695 2185 / +3902 2187 9628
E-mail : intek.com@intek-com.it

INTEK ELECTRONICS (CHINA), LIMITED
(Hong Kong Office)
8/F., CNT Commercial Building,
302 Queen's Road, Central, Hong Kong
E-mail : info@intek-radios.com

www.intek-radios.com

A World of



Electronics